

WIND PRESSURES ON STANDARD OIL COMPANY (INDIANA)
BUILDING -- WIND-TUNNEL STUDY

by

R. J. Kung*, S. Sethuraman**, and J. E. Cermak***

for

Edward Durell Stone & Associates and
The Perkins & Will Corporation
309 West Jackson Boulevard
Chicago, Illinois 60606

Fluid Mechanics Program
Fluid Dynamics and Diffusion Laboratory
Department of Civil Engineering
Colorado State University
Fort Collins, Colorado

September 1970

-
- * Research Associate
 - ** Graduate Research Assistant
 - *** Professor-in-Charge, Fluid Mechanics Program



U18401 0575772

CER70-71RJK-SS-JEC15

ACKNOWLEDGMENTS

The support of Edward Durrel Stone and Associates and the Parkins and Will Corporation in carrying out this study is gratefully acknowledged. The assistance of the machine shop in constructing the model is appreciated. The assistance of Mr. J. A. Garrison in taking photographs and a motion picture is highly appreciated.

TABLE OF CONTENTS

<u>Chapter</u>		<u>Page</u>
	ACKNOWLEDGEMENTS	i
	LIST OF TABLES	iii
	LIST OF FIGURES	iv
	LIST OF SYMBOLS	v
I	INTRODUCTION	1
II	EXPERIMENTAL APPARATUS	2
	2.1 Model Building	2
	2.2 Wind Tunnels	3
	2.3 Instrumentation	4
III	RESULTS	5
	3.1 The Mean Pressure Coefficient	5
	3.2 The Peak Pressure Coefficient	6
	3.3 RMS Pressure Coefficient	6
	3.4 Pressure on the Roof.	7
IV	CONCLUSIONS.	9
	REFERENCES	10

LIST OF TABLES

<u>Table</u>		<u>Page</u>
1	VARIATION OF LOCAL MEAN PRESSURE COEFFICIENTS WITH AZIMUTH ANGLE - MEASURED WITH RESPECT TO FREE STREAM STATIC PRESSURE	28
2	VARIATION OF LOCAL MEAN PRESSURE COEFFICIENTS WITH AZIMUTH ANGLE - MEASURED WITH RESPECT TO THE REAR TAPS	38
3	VARIATION OF LOCAL MEAN PRESSURES (LBS./S.FT.) WITH AZIMUTH ANGLE - MEASURED WITH RESPECT TO FREE STREAM STATIC PRESSURE	44
4	VARIATION OF LOCAL MEAN PRESSURES (LBS./S.FT.) WITH AZIMUTH ANGLE - MEASURED WITH RESPECT TO THE REAR TAPS	55
5	VARIATION OF LOCAL PEAK PRESSURE COEFFICIENTS WITH AZIMUTH ANGLE - MEASURED WITH RESPECT TO FREE STREAM STATIC PRESSURE	61
6	VARIATION OF LOCAL PEAK PRESSURE COEFFICIENTS WITH AZIMUTH ANGLE - MEASURED WITH RESPECT TO THE REAR TAPS	71
7	VARIATION OF LOCAL PEAK PRESSURES (LBS./S.FT.) WITH AZIMUTH ANGLE - MEASURED WITH RESPECT TO FREE STREAM STATIC PRESSURE	77
8	VARIATION OF LOCAL PEAK PRESSURES (LBS./S.FT.) WITH AZIMUTH ANGLE - MEASURED WITH RESPECT TO THE REAR TAPS	88
9	VARIATION OF THE RMS VALUE OF THE LOCAL FLUCTUATING PRESSURE WITH AZIMUTH ANGLE	94
10	VARIATION OF THE MEAN PRESSURE COEFFICIENTS AND LOCAL MAXIMUM PRESSURE COEFFICIENTS WITH AZIMUTH ANGLE FOR THE TAPS ON THE ROOF.	99

LIST OF FIGURES

<u>Figure</u>	<u>Page</u>
2-1 Dimensions of the Model Building	11
2-2 Photograph of the Model Building	12
2-3 Location of the Pressure Taps.	13
2-4 Model and Turn Table Assembly.	14
2-5 Plan View of the Meteorological Wind Tunnel.	15
2-6 Plan View of the Environmental Wind Tunnel	16
2-7 Calibration Curves of the Transducers.	17
2-8 Block Diagram of the Measuring System.	18
2-9 General View of the Measuring Equipment.	19
3-1 Time Recording of Positions $C_5, C_6, F_1, F_2, F_3,$ and F_4 at $\alpha = 0^\circ$	20
3-1-A Estimated Maximum Pressure Profile - Pressure Taps in the Center of Upwind Face (Speed 120 M.P.H.)	21
3-2 RMS Tracing on Tap D_3 Between -30 to +30	22
3-3 RMS Pressure Coefficient vs. Azimuth Angle	23
3-4 Flow Pattern at $\alpha = 0^\circ$	24
3-5 Flow Pattern at $\alpha = 25^\circ$	25
3-6 Flow Pattern at $\alpha = -15^\circ$	26
3-7 Flow Pattern on the Roof	27

LIST OF SYMBOLS

Symbol

$C_{\bar{p}}$	The mean pressure coefficient, $\bar{p}/\frac{\rho}{2} U_{\infty}^2$
$C_{\bar{p}_d}$	Mean pressure-difference coefficient for chevron columns, $p_F - p_B / \frac{\rho}{2} U_{\infty}^2$
$C_{p_d \max}$	Peak pressure-difference coefficient for chevron columns, $1/2 [(p_F - p_B)_{\max} - (p_F - p_B)_{\min}] / \frac{\rho}{2} U_{\infty}^2$
$C'_{p_{\max}}$	Peak pressure coefficient, $\frac{1}{2} (p'_{\max} - p'_{\min}) / \frac{\rho}{2} U_{\infty}^2$
$C'_{p_{\text{rms}}}$	RMS pressure coefficient, $p'_{\text{rms}} / \frac{\rho}{2} U_{\infty}^2$
\bar{p}	The mean pressure, $\overline{p_i - p_{\infty}}$
p_i	Instantaneous pressure at surface piezometer
\bar{p}_B	Mean pressure acting on B tap
\bar{p}_F	Mean pressure acting on F tap
p'_{\max}	Local maximum pressure, $(p_i - p_{\infty})_{\max}$
p'_{\min}	Local minimum pressure, $(p_i - p_{\infty})_{\min}$
p'_{rms}	RMS value of the local fluctuating pressure, $[(p_i - p_{\infty})^2]^{\frac{1}{2}}$
p_{∞}	Mean undisturbed pressure
U_{∞}	Reference wind speed at free-stream
ρ	Mass density of air
α	Azimuth angle of approach wind
$(\bar{\quad})$	Time average

I. INTRODUCTION

A modeling test on the Standard Oil Company (Indiana) Building was studied at the Fluid Dynamics and Diffusion Laboratory of Colorado State University. The main purpose of this study was to determine characteristic features of wind pressures on exterior surfaces of the building. The re-entrant corners and the chevron column paces produce separated flows which can introduce large pressure fluctuations. Information on the magnitude of these pressure fluctuations, which can be obtained only from a wind-tunnel study, is important for the design of cladding panels to be used on the building surface.

The proposed building is approximately 1,100 ft high with a symmetric cross section approximately 200 ft by 200 ft. A 1:98 scale model was constructed for the top 300 ft of the building. This model building was subjected to an uniform flow near the entrance of the wind tunnel in an effort to isolate the pressure fluctuations produced by separation and reattachment of the flow. Mean pressures, peak pressures, and root-mean-square values of the fluctuating pressure were measured directly by high-response pressure transducers. Smoke was introduced into the flow to make the overall flow patterns visible. A motion picture* was made to provide a permanent record of the flow patterns for several wind directions. Results in this report are given in non-dimensional coefficients. The pressures for a particular design wind speed can be obtained by multiplying the reference design dynamic pressure by the appropriate coefficients.

*16mm, black and white, silent

II. EXPERIMENTAL APPARATUS

The main objective of this study was to measure the mean and fluctuating pressures on the exterior surface of a rigid model building. Since surface geometry of the building may introduce local flow characteristics, which produce major fluctuations of pressure, the model was tested in an uniform air stream in an effort to define these peculiar effects. Direct measurements of mean pressures, instantaneous peak pressures, and root-mean-square (RMS) values of the exterior surface pressures were made.

Descriptions of the model, the wind tunnels, and the instrumentation are given in the following sections.

2.1 Model Building

In order to obtain an accurate measurement of local pressure by means of piezometer taps, the model was constructed to as large a scale as possible without introducing serious blockage of the wind tunnel. A 1:98 scale replica of the upper 300 ft of the building was selected. The model was built from 3/8 in. thick "Lucite" sheets and the chevron column paces were modeled by cementing triangular plastic strips to the plane surface. Dimensions of the model building are shown in Figure 2-1. A photograph of the model building is shown in Figure 2-2.

Piezometer taps (1/16 in. dia.) were drilled normal to the exterior wall on the chevron columns, the re-entrant corners, and on the roof. Because of building symmetry, pressure taps were drilled on only one complete face and one re-entrant corner. These taps were placed in a band at a level approximately 150 ft below the top. After the critical azimuth angle was obtained from an initial test, more taps were drilled

on one side of another re-entrant corner and two adjacent chevron columns for a detailed study. Figure 2-3 shows the location and designation of each tap.

The model building was fastened on a turntable which can indicate the angle of rotation with an accuracy of ± 0.1 degree. Figure 2-4 is a sketch of the model and the turntable. The rotation angle of the model building can be read either from the voltage output of a potentiometer geared to the base or from the scale engraved on the turntable.

2.2 Wind Tunnels

The experimental investigation was conducted in two wind tunnels of the Fluid Dynamics and Diffusion Laboratory at Colorado State University. These are the meteorological wind tunnel (MWT) and the environmental wind tunnel (EWT). The MWT is a recirculating type with a normal cross section of 6 x 6 ft. The mean velocity in the test section can be adjusted continuously from 0 to 120 fps (Fig. 2-5). This facility is described by Plate and Cermak (1963). The EWT is an open-circuit type with a normal cross section, 8 ft high and 12 ft wide. A 150 hp AC motor is used to drive the blower. The mean velocity can be adjusted from 0 to 23 fps by varying the fan pitch. Figure 2-6 shows a plane view of the EWT.

When the model building was placed in the MWT, the maximum and minimum blockages were 22% and 17.3%, respectively. On the other hand, the maximum and minimum blockages in the EWT were 8.3% and 6.5%, respectively. It was intended to make all measurements in the EWT because of the small blockage. However, since the acoustical noise from the fan in the EWT produced pressure fluctuations, the level inside the EWT was comparable in magnitude to those produced by the local flow

instabilities, measurements on instantaneous peak, mean, and RMS of local pressures were conducted in the MWT. The flow visualization was conducted in the EWT.

2.3 Instrumentation

Six "Statham" differential pressure transducers (Model PM283) were used to measure the mean pressure and its fluctuating component. The transducers were mounted inside the model building and vinyl tubing (3 in. long, 1/8 in. I.D.) was used to connect each transducer to a pressure tap. Pressure transducers were calibrated against an electronic pressure monometer (Transonic type 120). Figure 2-7 shows the calibration curves of all six transducers.

A 1/8 in. standard pitot static tube, located 3 ft upstream and 2 ft above the model building, was used to measure the free-stream velocity. The static pressure tap of the pitot tube was also connected to the "Reference" port of the "Statham" transducers. With this arrangement, the pressure measured by the transducer was the pressure difference between the local surface pressure and the static pressure in the free-stream.

A multi-channel Visicorder (Model 1612) was used to record the mean and the fluctuating component of the local pressure. A 14-channel tape recorder (Ampex model) was employed to record the fluctuating pressure for future analysis. The root-mean-square (RMS) value of the fluctuating pressure was measured through a Disa True-RMS meter (Model 55 D35) together with a Mosely x-y plotter (Model 135). A Tektronix storage oscilloscope (Type 562) and a Hewlett-Packard Model 3440A digital voltmeter were used to calibrate the transducers and to check the output

signal during the experiment. Figure 2-8 is a block diagram of the measuring system. A general view of the equipment is shown in Fig. 2-9.

III. RESULTS

The output of all six pressure transducers were recorded simultaneously on the visicorder. The mean pressure, \bar{p} , and the instantaneous peak pressure, p'_{\max} , were determined from the recording chart. Figure 3-1 is a typical trace of the local pressure for position C_5 , C_6 , F_1 , F_2 , F_3 , and F_4 . The arrows at the left side of Fig. 3-1 indicate the zero recording level, i.e., at zero velocity. The RMS value of the local fluctuating pressure was measured by the RMS meter. A typical trace of the RMS pressure vs azimuth angle is shown in Fig. 3-2.

3.1 The Mean Pressure Coefficient

The mean pressure coefficient, $C_{\bar{p}}$, is defined as follows:

$$C_{\bar{p}} = \frac{\bar{p}}{\frac{1}{2} \rho U_{\infty}^2} \quad (1)$$

where ρ is the air mass density, U_{∞} is the reference wind speed at freestream and \bar{p} represents the local mean pressure measured with respect to the free-stream static pressure. Table 1 is the measure $C_{\bar{p}}$ for all taps at different azimuth angles. Table 2 shows the coefficient of mean pressure difference acting on the chevron columns. This was obtained by connecting the "High" port of the transducer to a F tap and the "Low" port to the corresponding B tap. The pressure difference coefficient is defined as:

$$C_{p_d} = \frac{p_F - p_B}{\frac{1}{2} \rho U_{\infty}^2} \quad (2)$$

where p_F represents the pressure acting on the F tap and p_B is the pressure acting on the B tap. Table 3 shows the local mean pressure, \bar{p} at different azimuth angles. Table 4 indicates the mean pressure difference acting on the chevron columns. These pressures have been computed for the design speed of 120 m.p.h.

3.2 The Peak Pressure Coefficient

The local peak pressure is defined as one half of the local maximum to minimum pressure fluctuation. Consider p'_{\max} as the local maximum pressure and p'_{\min} as the local minimum pressure, the peak pressure coefficient $C'_{p_{\max}}$ is defined as

$$C'_{p_{\max}} = \frac{\frac{1}{2} (p'_{\max} - p'_{\min})}{\frac{1}{2} \rho U_{\infty}^2} \quad (3)$$

Table 5 shows the local peak pressure coefficients.

The peak pressure between the F tap and B tap of each chevron column $C_{p_d \max}$ was also measured. Table 6 shows the peak pressure coefficient between two taps on each chevron column. Table 7 gives the local peak pressures and Table 8 the peak pressure on each chevron column for the design wind speed of 120 m.p.h.

An estimated maximum pressure profile with the pressure taps in the center of upwind face for a wind speed of 120 miles per hour is shown in Figure 3-1-A.

3.3 RMS Pressure Coefficient

The fluctuating pressure can be represented in a statistical sense by using a RMS meter to measure the root-mean-square value of the local

fluctuating pressure. Consider p'_{rms} as the RMS value of the local fluctuating pressure, the RMS pressure coefficient is then defined as

$$C'_{P_{rms}} = \frac{p'_{rms}}{\frac{1}{2} \rho U_{\infty}^2} \quad (4)$$

Figure 3-3 is a plot of the local $C'_{P_{rms}}$ vs the azimuth angle α . The numerical values of $C'_{P_{rms}}$ are shown in Table 9.

The flow pattern at $\alpha = 0^{\circ}$ is shown in Fig. 3-4. Flow separates from one edge of the re-entrant corner and reattaches at the opposite edge of the re-entrant corner. From Fig. 3-3 or from Table 5 the RMS pressure coefficient, $C'_{P_{rms}}$, of tap C_6 , which is located at the reattachment point, is found to have a higher $C'_{P_{rms}}$ value than any other tap. Visualization of the flow also showed that as α was increased from zero the flow first separated from the first chevron column and reattached on the side surface of the building. Figure 3-5 is a picture of the flow pattern at an azimuth angle $\alpha = 25^{\circ}$. The flow reattached in the neighborhood of F_5 giving a maximum of $C'_{P_{rms}}$ at this point (see Fig. 3-3). The RMS pressure coefficients of the taps downstream from F_5 have maxima near $\alpha = 25^{\circ}$. These maxima are a good indication that flow reattachment is taking place. Figure 3-6 shows the pattern of flow at an azimuth angle $\alpha = -15^{\circ}$. The flow is seen to be reattaching at C_6 which also corresponds to an instantaneous peak in Fig. 3-3.

3.4 Pressure on the Roof

The mean and fluctuating pressures on the roof of the building were measured along the center line. Definition of the mean and peak pressure coefficients are the same as in Eqs. (1) and (3) respectively. Table 10 gives values of $C_{\bar{p}}$ and $C_{P'_{max}}$ at different locations on the roof.

Since the flow separated from the up-stream edge of the roof and did not reattach on the roof, smoke released from the down-stream portion of the roof was initially carried up-stream (see Fig. 3-6).

IV. CONCLUSIONS

Results of this study are summarized in the following statements:

(1) The maximum negative mean pressure coefficient measured in this study was 2.546 which occurred on tap D_2 , at an azimuth angle of $+14^\circ$. The maximum negative mean pressure coefficient measured on roof was 2.081 on tap T_7 .

(2) The maximum peak pressure coefficient measured in this study was 1.630 which occurred on tap C_6 at an azimuth angle of $+5^\circ$.

(3) The RMS pressure coefficient can be used to locate the re-attachment point at a given azimuth angle. Or at a given location, a maximum in the value of $C_{p'_{rms}}$ indicates that the flow has reattached at that location.

(4) This study was carried out in a uniform flow with a model of only the upper 300 ft of the building in an effort to isolate the separation-induced pressure fluctuations. In order to have a better understanding of the total aerodynamical effect on the building, a wind tunnel study with a smaller scale model of the entire building placed in a simulated atmospheric boundary layer should be undertaken.

REFERENCES

Marshall, R.D. and J.E. Cermak (1966). "Wind Studies of Bank of America World Headquarters Building; Part II - Wind Tunnel Study." CER66-67RDM-JEC19, College of Engineering. Colorado State University.

Plate, E.J., and J.E. Cermak (1963). "Micro-meteorological Wind Tunnel Facility, Description and Characteristics." CER63EJP-JEC9, College of Engineering. Colorado State University.

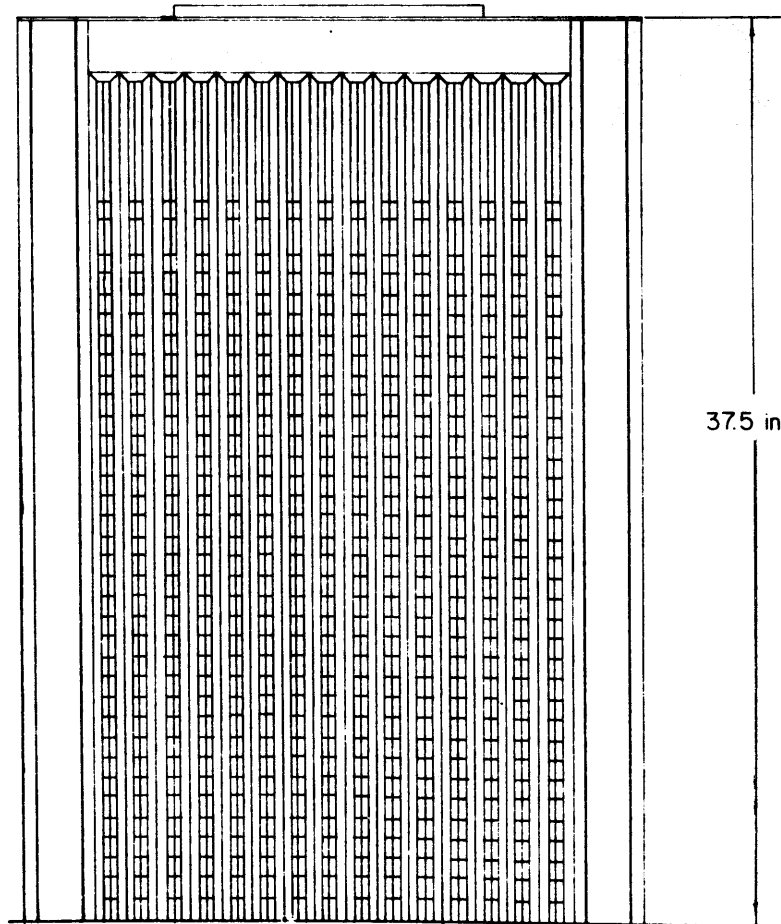
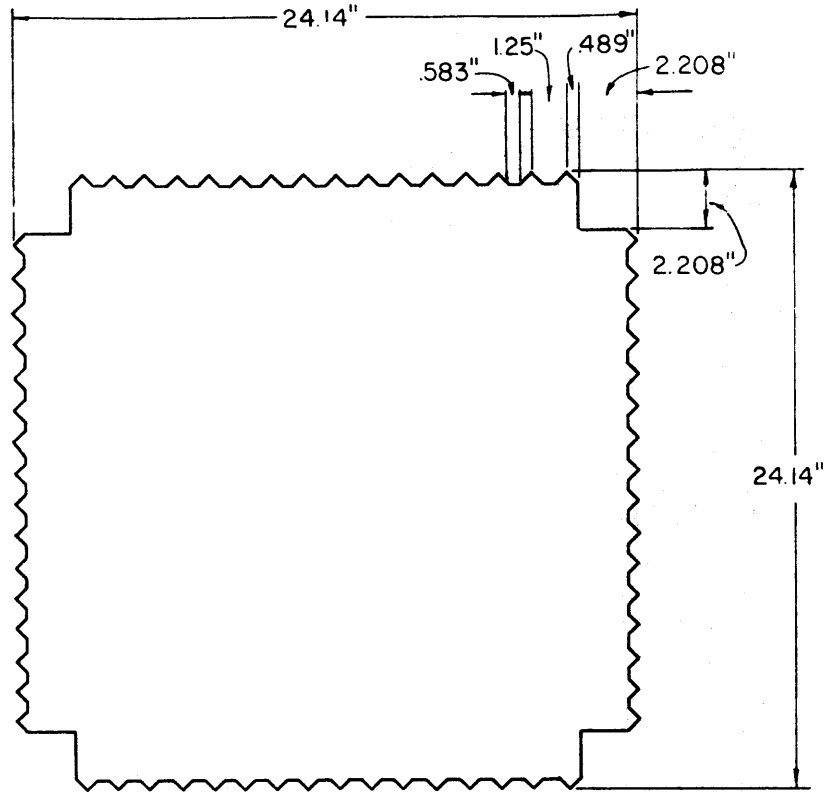

Fig. 2-1. Dimensions of the model building.

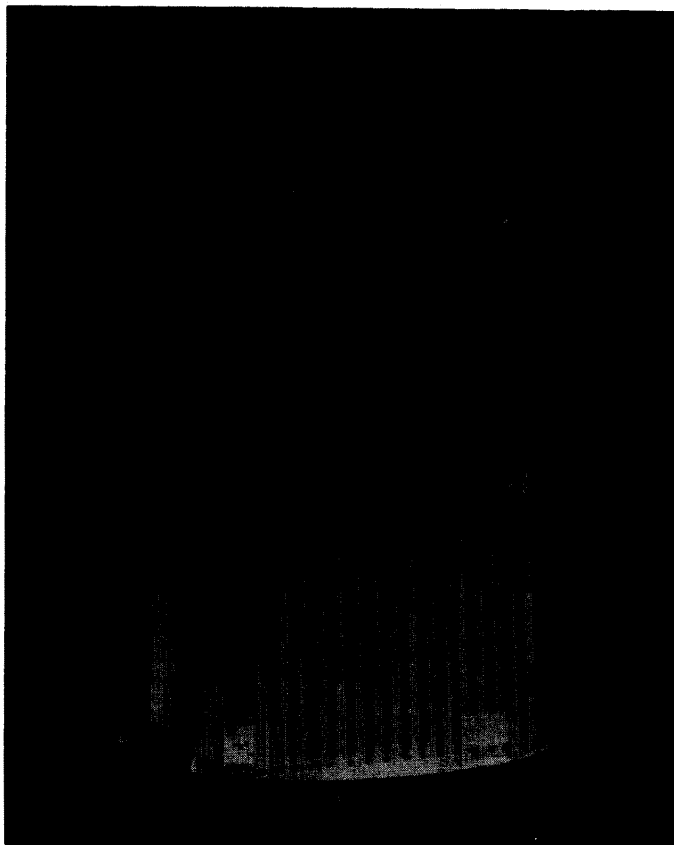

Fig. 2-2. Photograph of the model building.

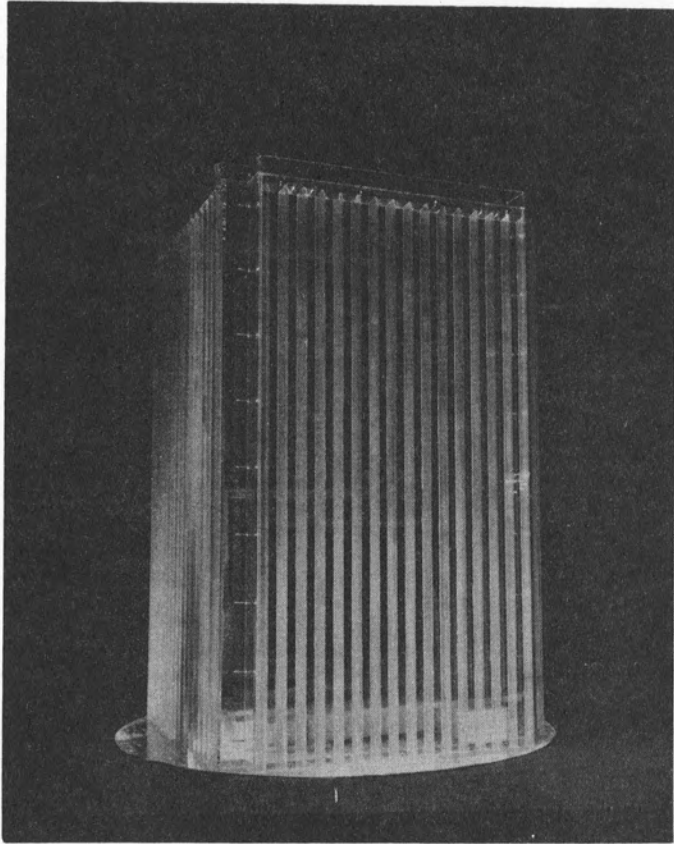

Fig. 2-2. Photograph of the model building.

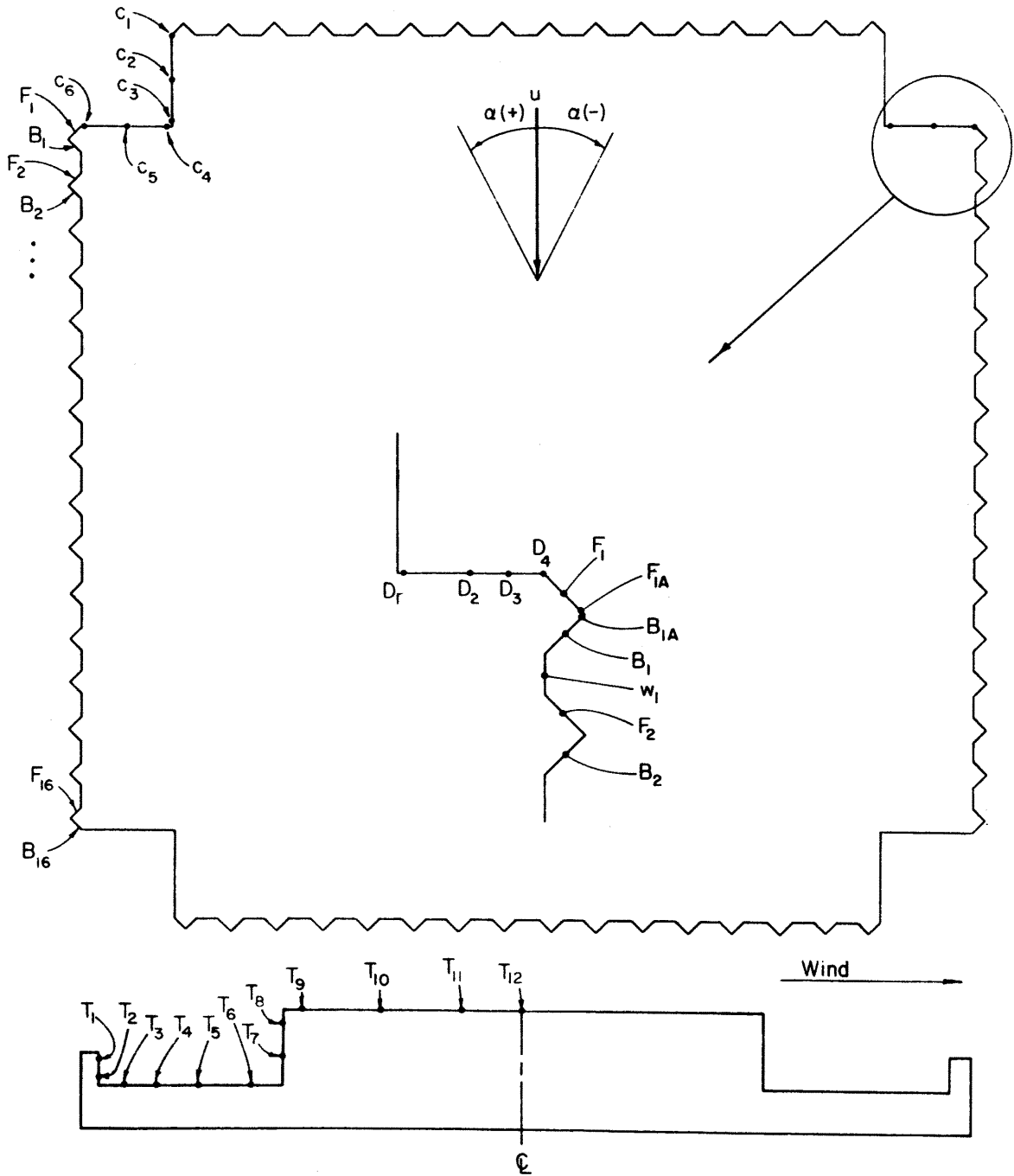

Fig. 2-3. Location of the pressure taps.

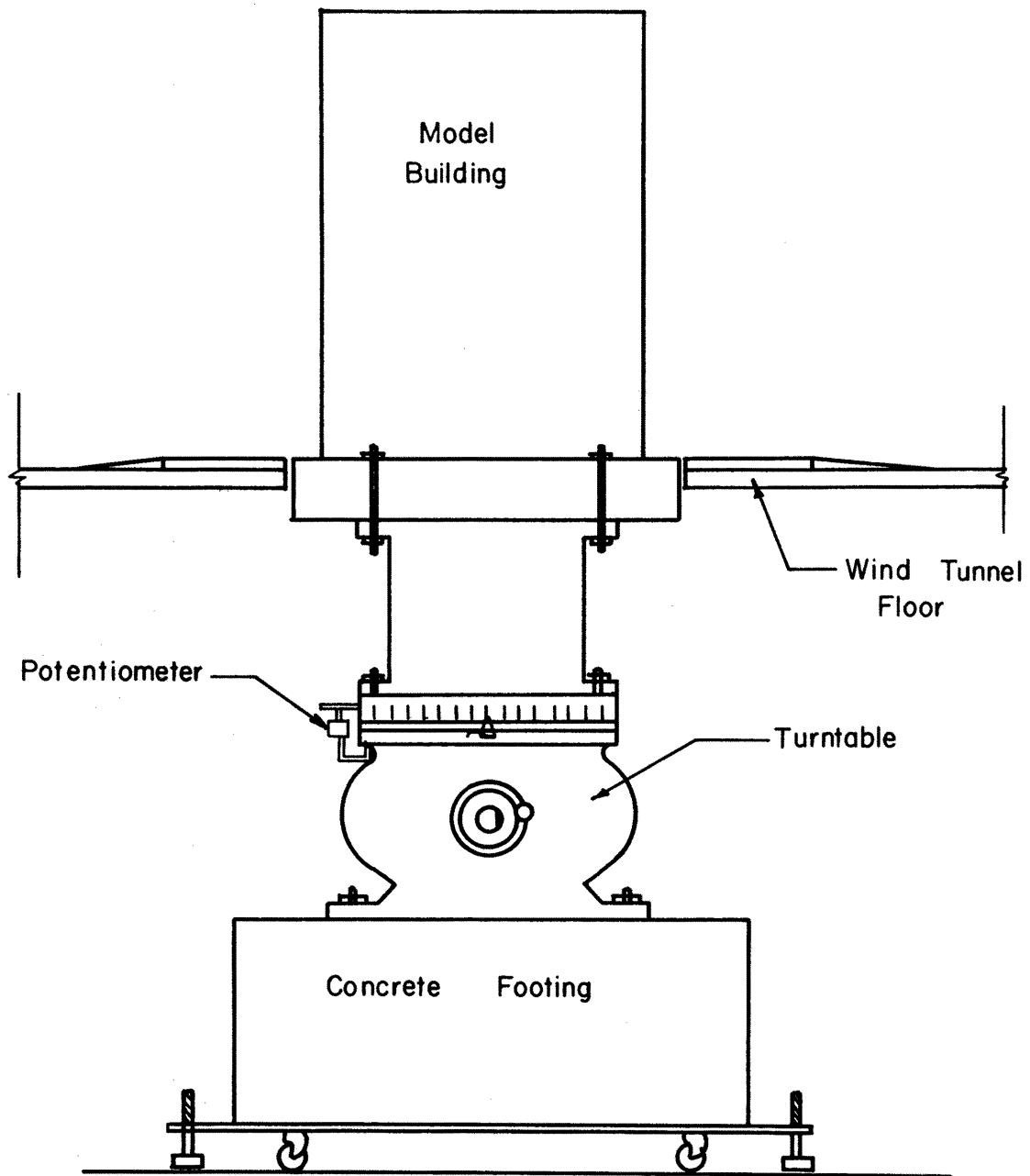

Fig. 2-4. Model and turntable assembly.

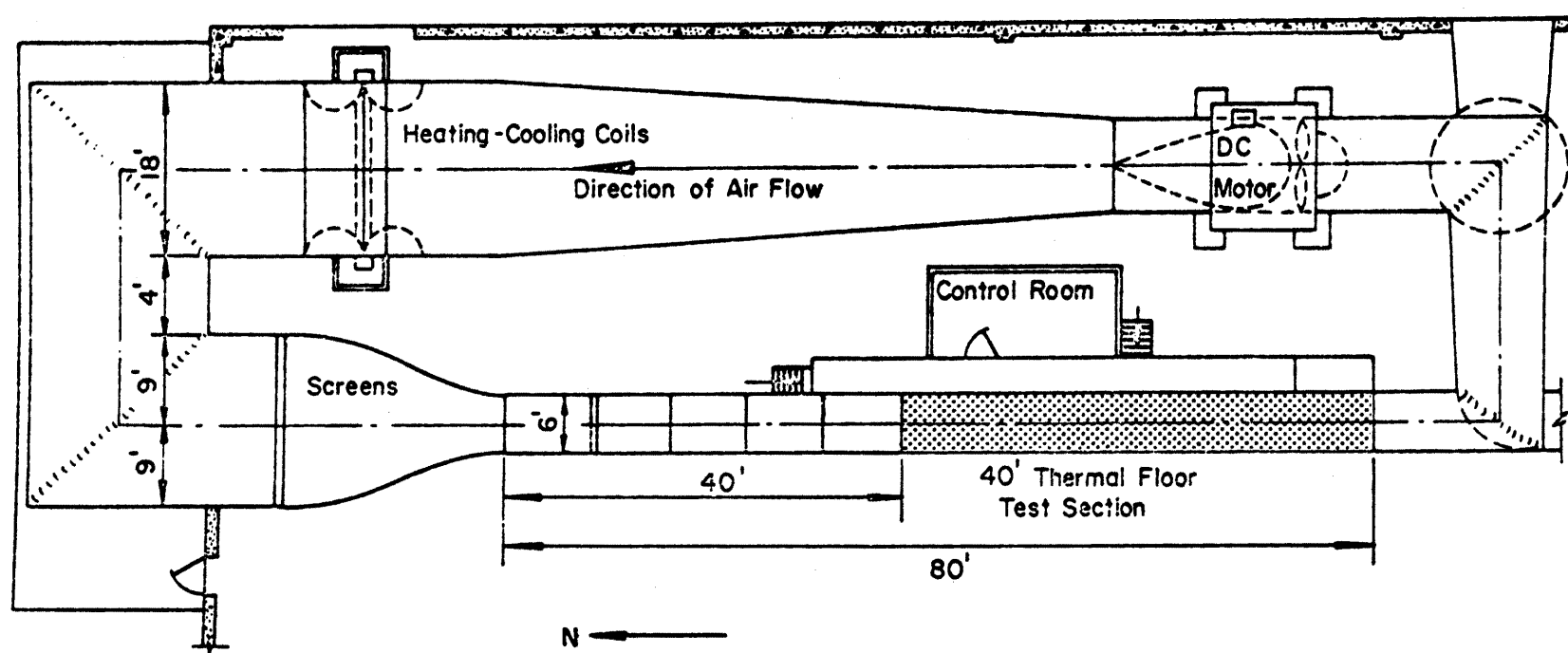

Fig. 2-5. Plan view of the meteorological wind tunnel.

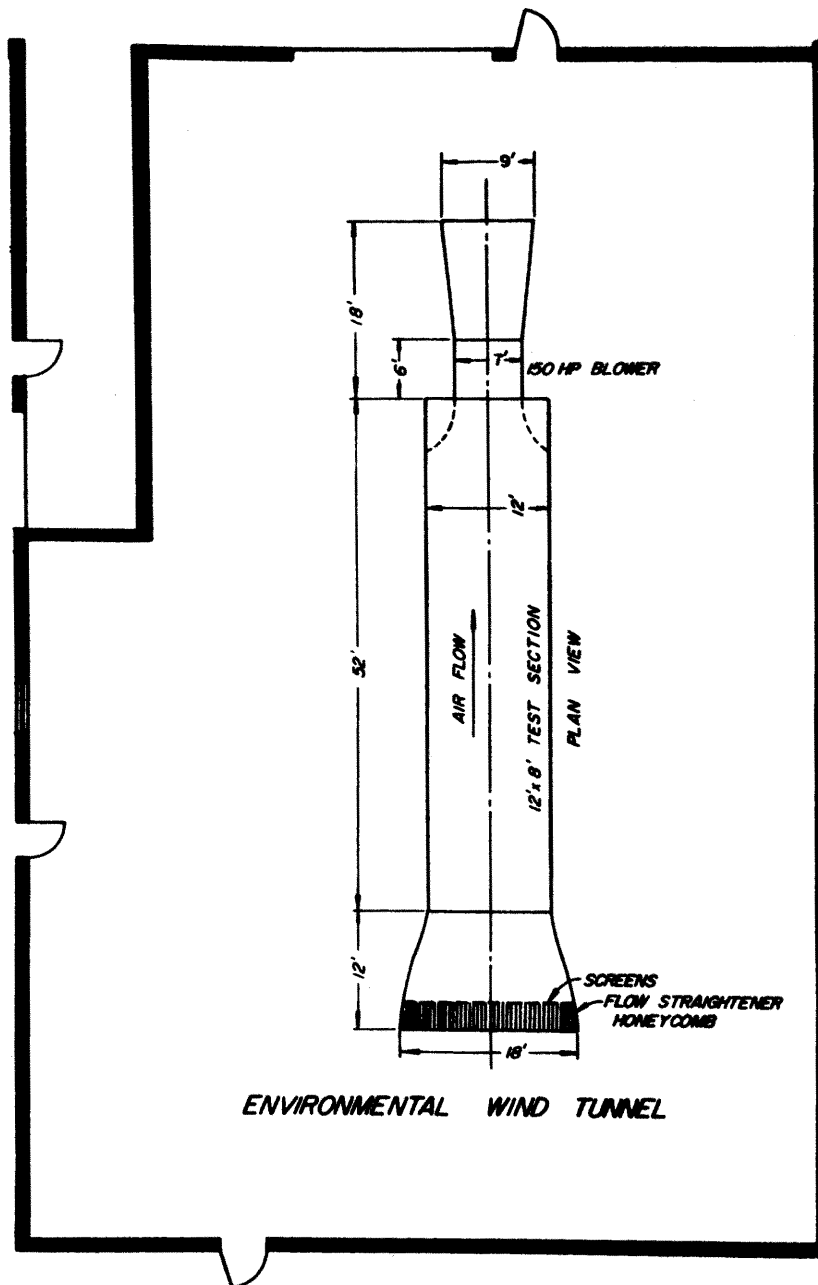

Fig. 2-6. Plan view of the EWT.

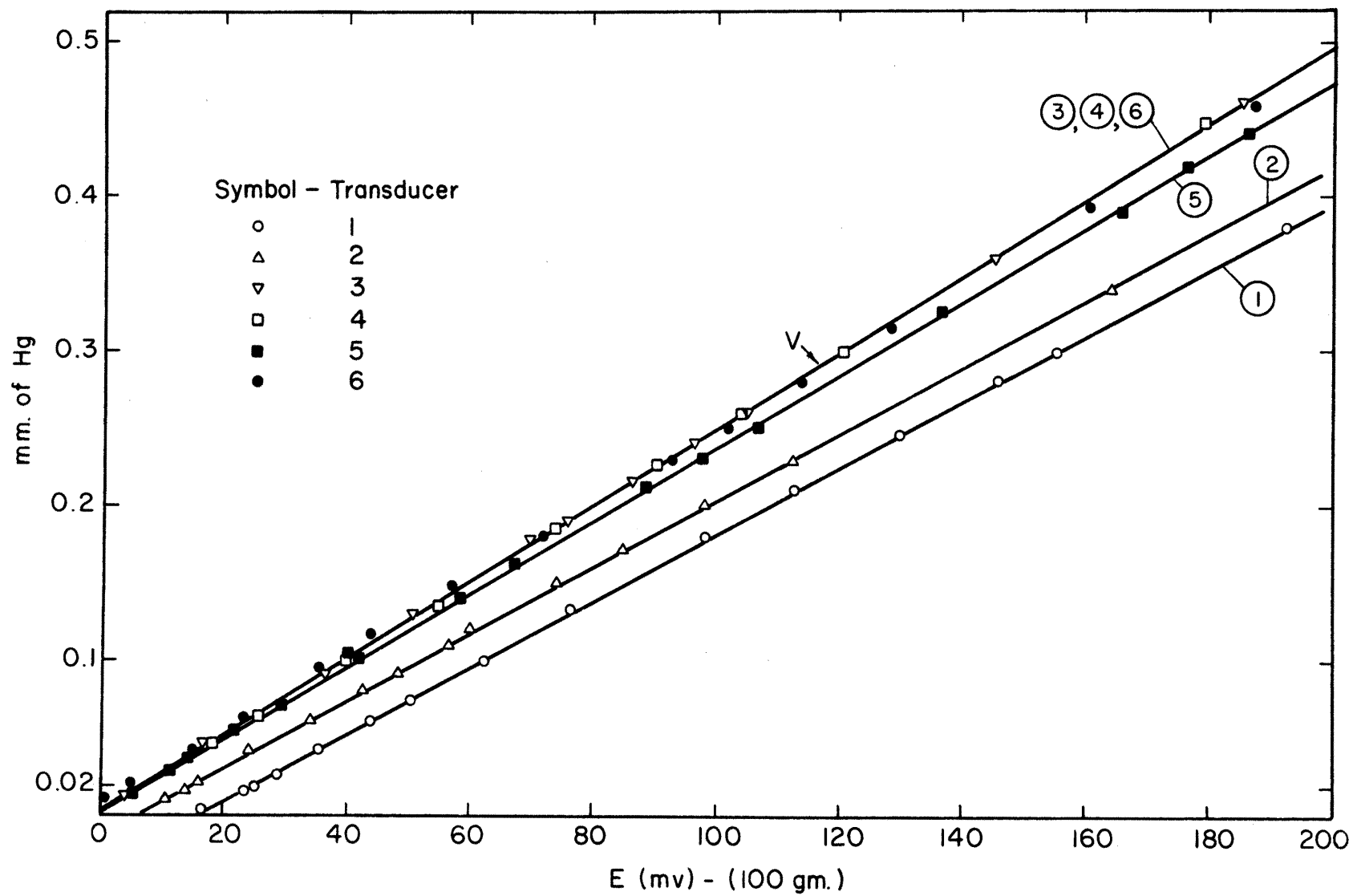

Fig. 2-8. Calibration Curves of the Transducers

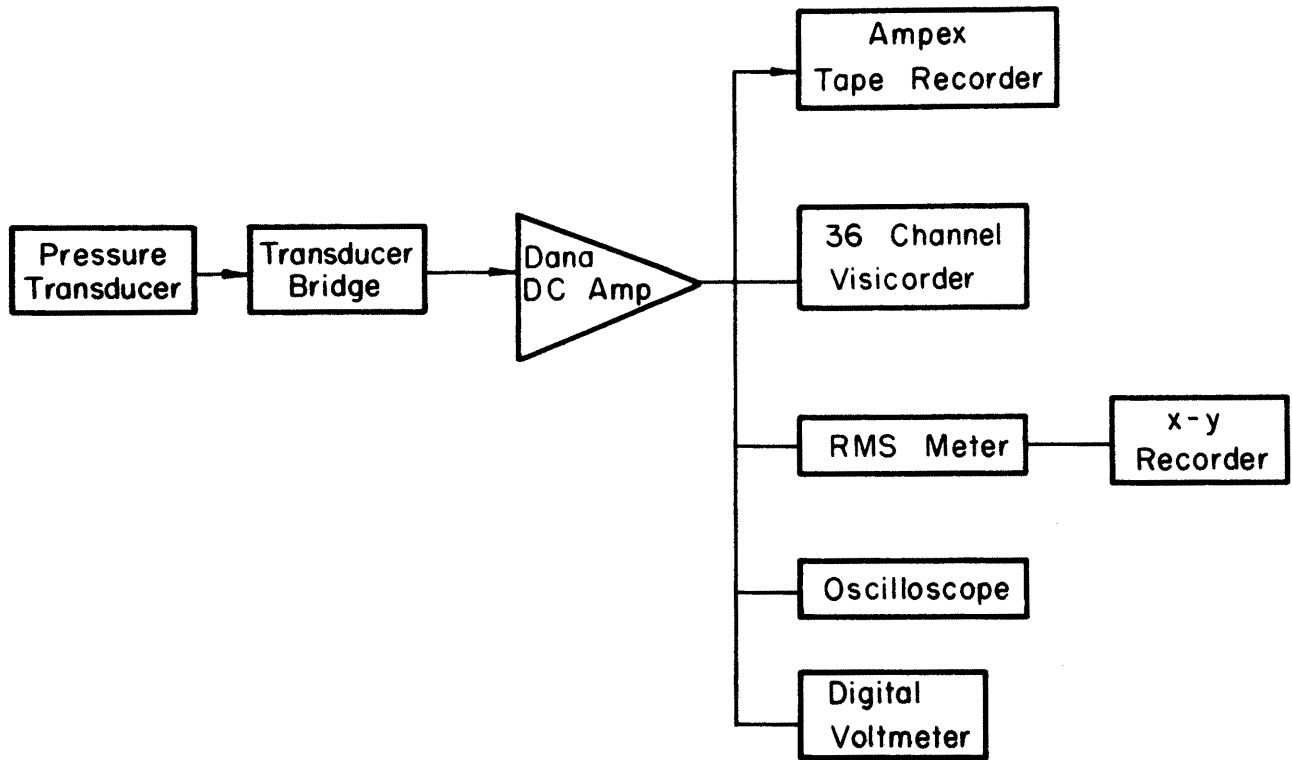

Fig. 2-8. Block diagram of the measuring system.



Fig. 2-9. General view of the measuring equipment.



Fig. 2-9. General view of the measuring equipment.

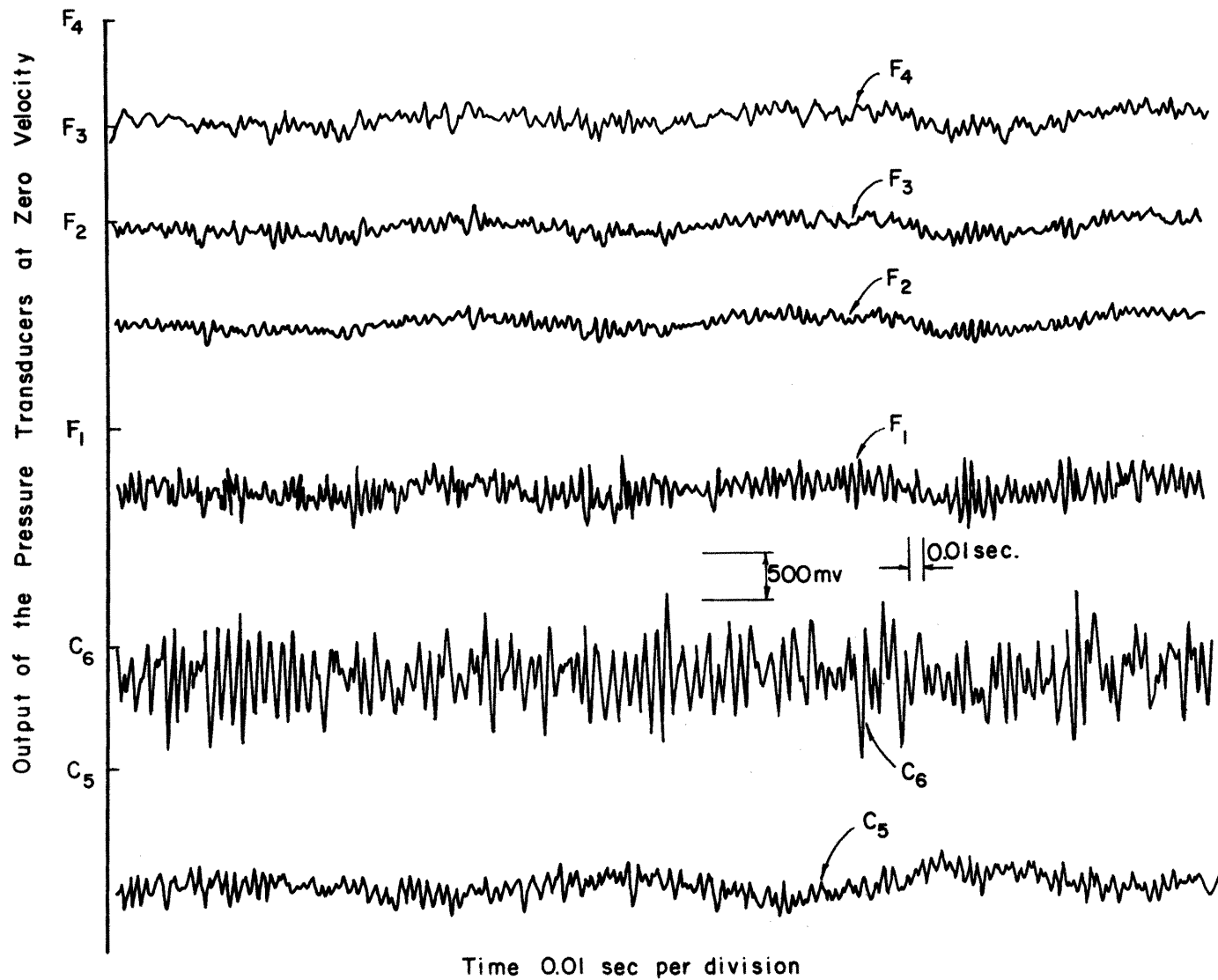
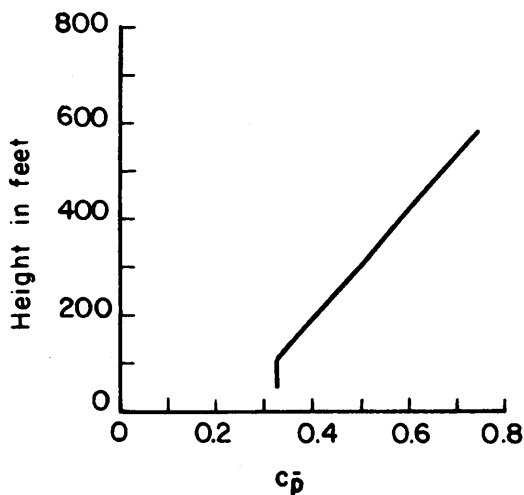
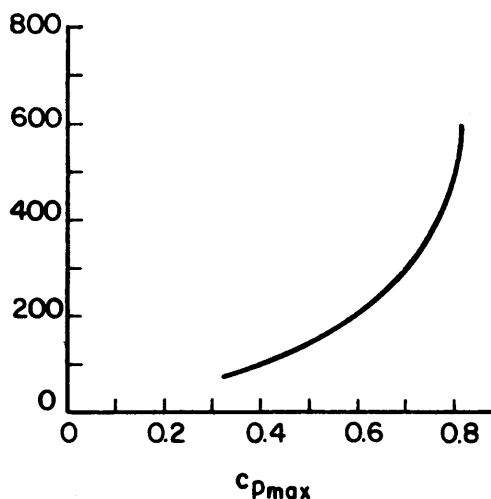

Fig. 3-1. Time recording of positions C_5 , C_6 , F_1 , F_2 , F_3 and F_4 at $\alpha = 0^\circ$.

Components of Max. Instantaneous Pressure Used to Estimate the Profile
in Figure 3-1-A.



(from Atlantic Richfield Buildings model study)



(From U.S. Steel Building model study)

$$\text{Total pressure} = (C_p + C_{p_{max}}) \frac{\rho U^2}{2}$$

For $\rho = 0.00207 \text{ slugs/ft}^3$ and

$$U_{\infty} = 176 \text{ ft/sec. (equivalent to 120 mph),}$$

the total pressure shown in Fig. 3-1-A becomes

$$\text{Total pressure} = (C_p + C_{p_{max}}) 32.09$$

References for this estimate:

- Davenport, A.C. and N. Isyumov (1967); A Wind Tunnel Study for the United States Steel Building, Eng. Science Research Report BLWT-5-1967, The University of Western Ontario, London, Canada.
Sadeh, W.Z., J.E. Cermak, and G. Hsi (1969); A Study of Wind Loading on Structures - - Atlantic-Richfield Plaza Buildings, CER68-69WZS-JEC-GH-36, Colorado State University, Fort Collins, Colorado.

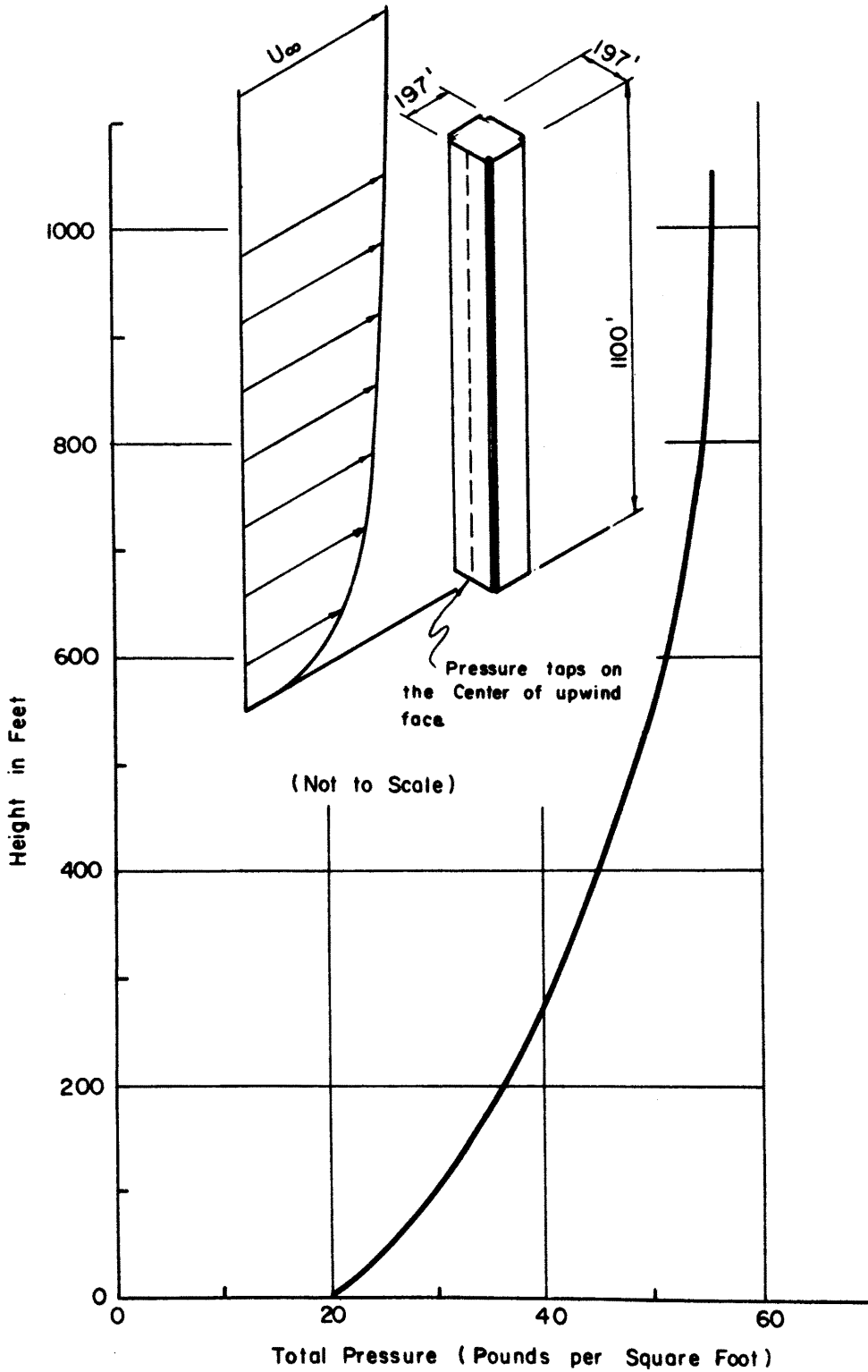

Fig. 3-1-A. Estimated maximum pressure profile -- pressure taps in the center of up-wind face - (speed 120 m.p.h.).

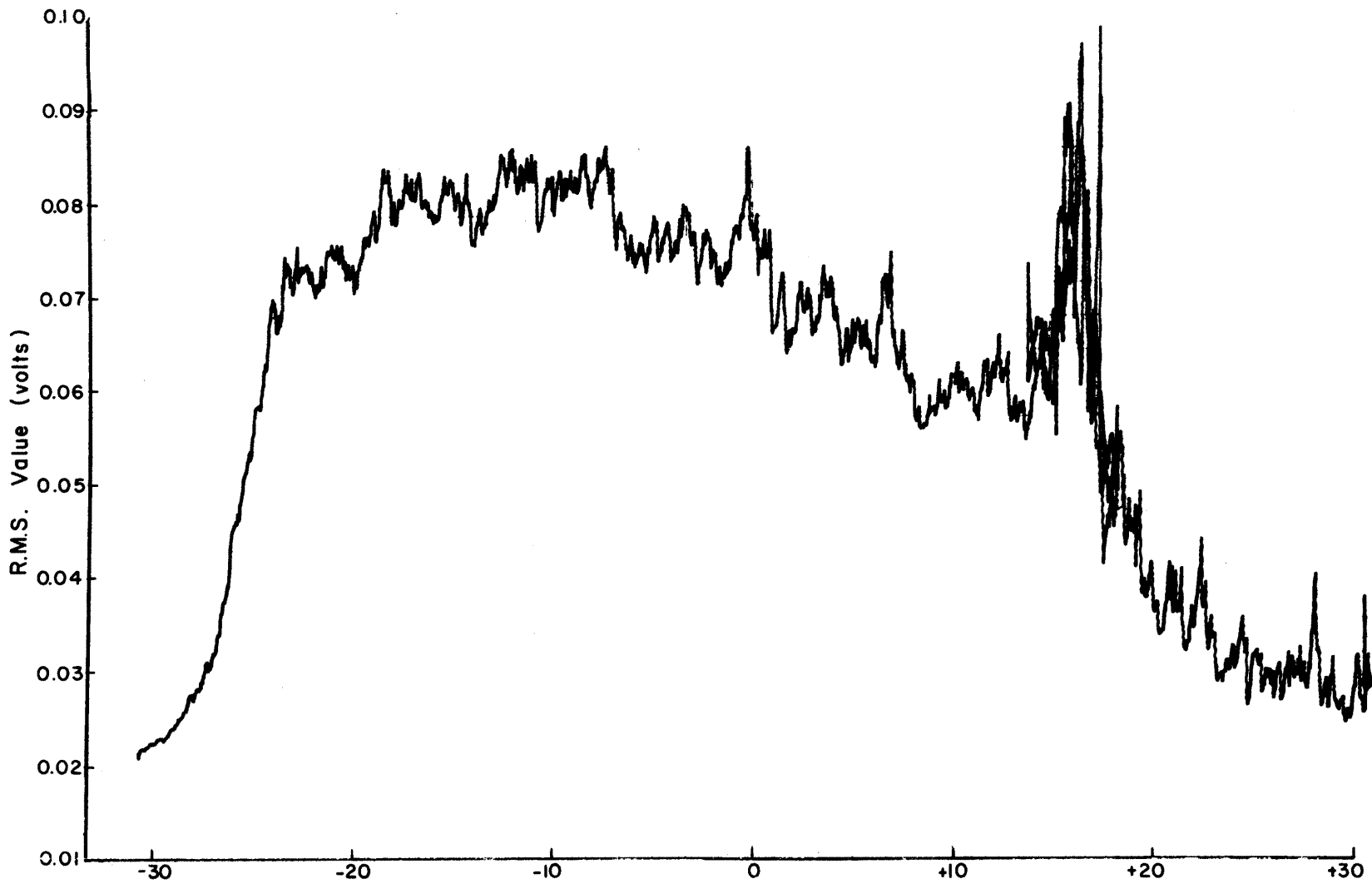

Fig. 3-2. RMS tracing on tap D_3 between - 30 and + 30.

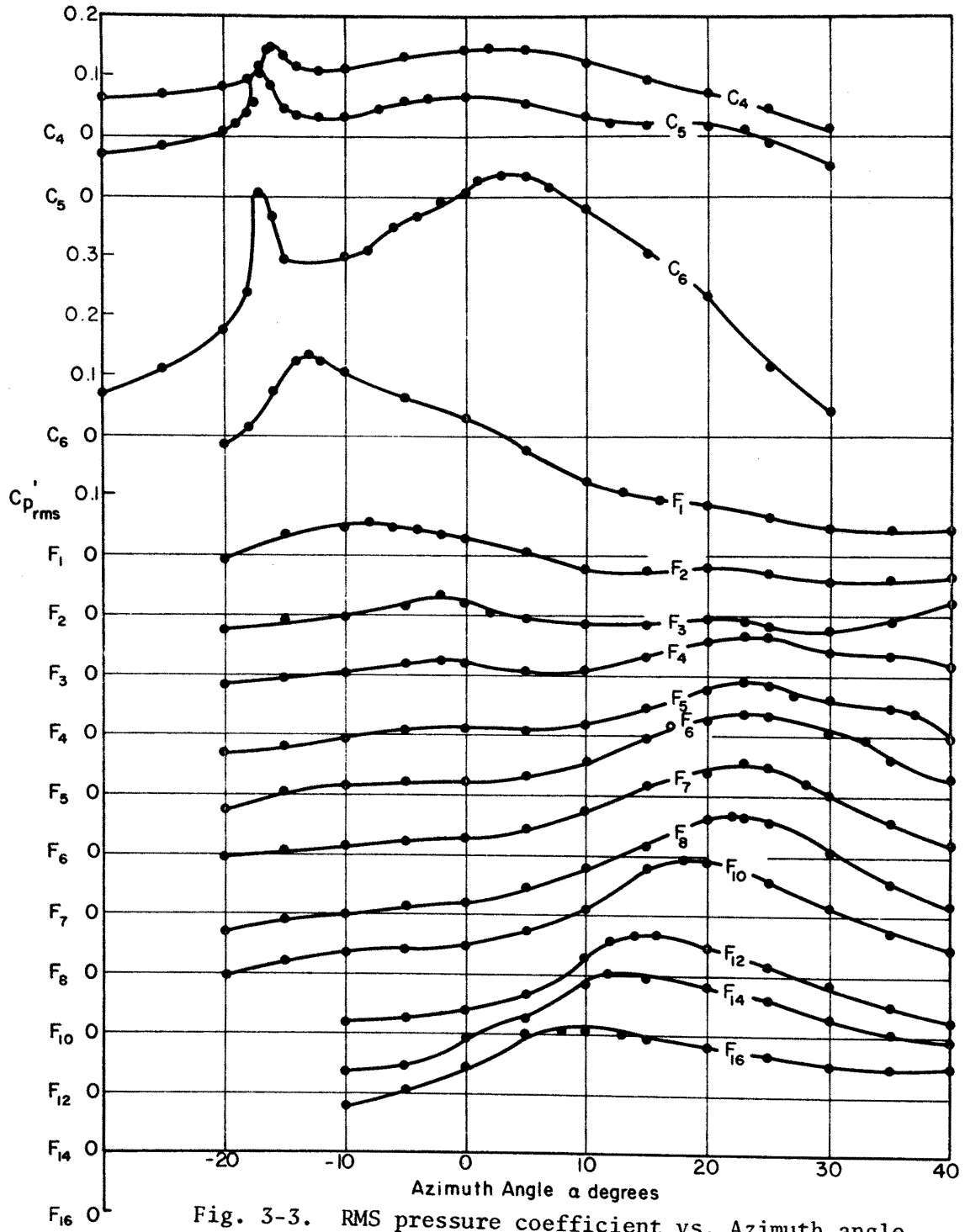

Fig. 3-3. RMS pressure coefficient vs. Azimuth angle.

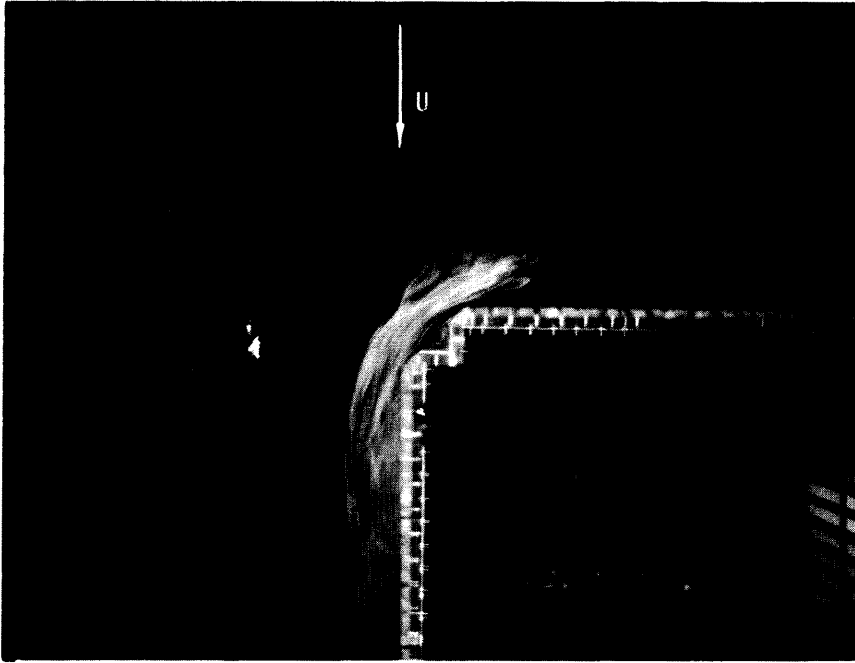

Fig. 3-4. Flow pattern at $\alpha = 0^\circ$.

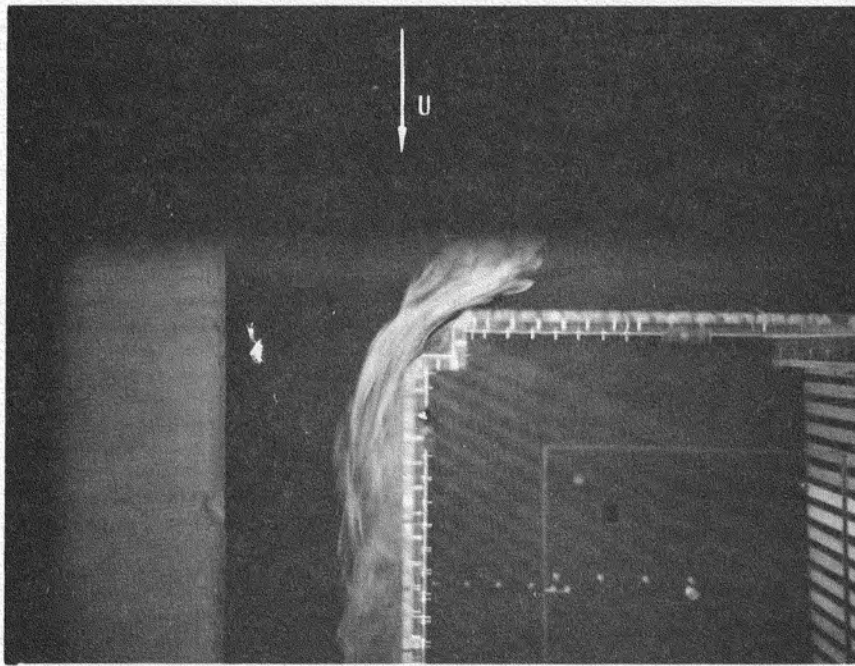

Fig. 3-4. Flow pattern at $\alpha = 0^\circ$.

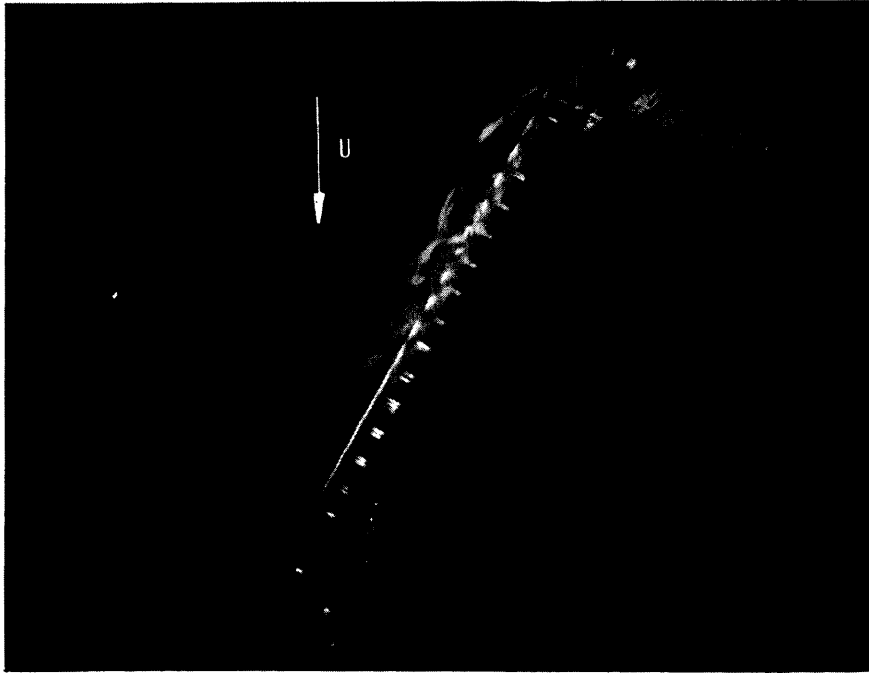

Fig. 3-5. Flow pattern at $\alpha = 25^\circ$.

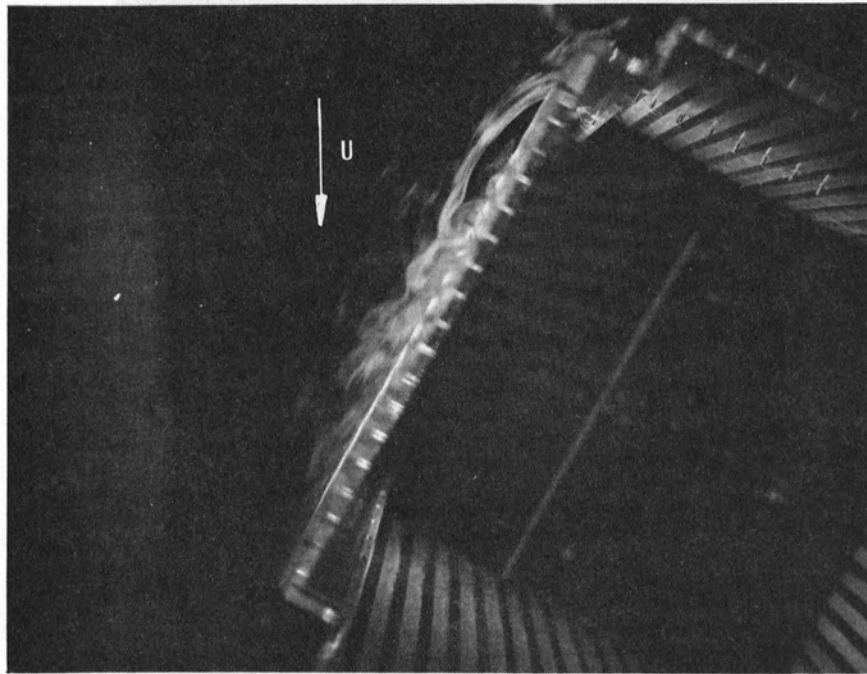

Fig. 3-5. Flow pattern at $\alpha = 25^\circ$.

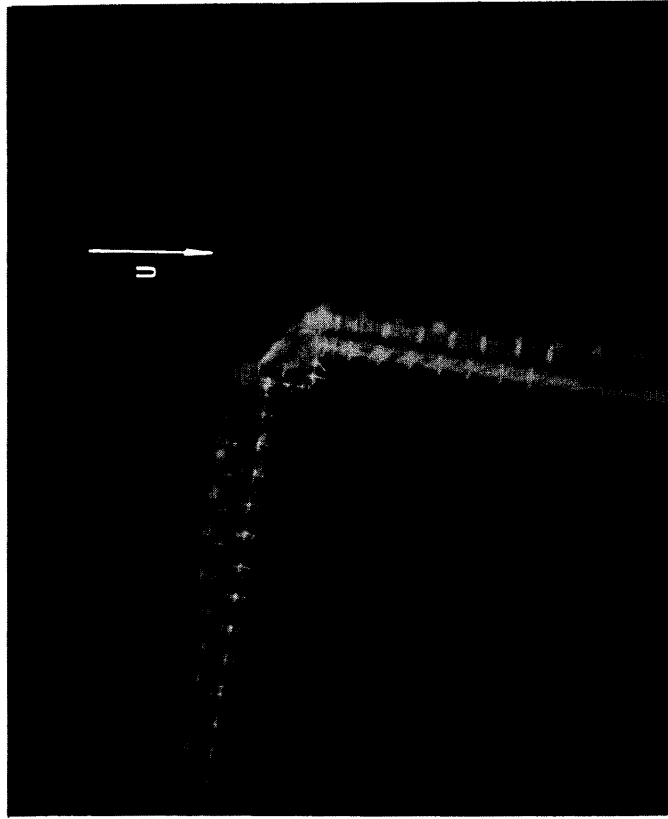

Fig. 3-6. Flow pattern at $\alpha = -15^\circ$

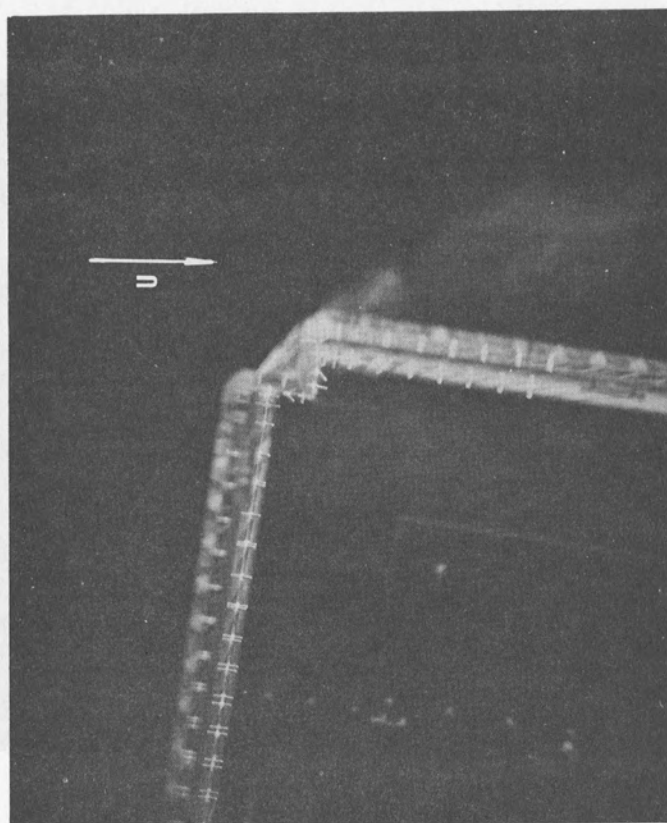

Fig. 3-6. Flow pattern at $\alpha = -15^\circ$

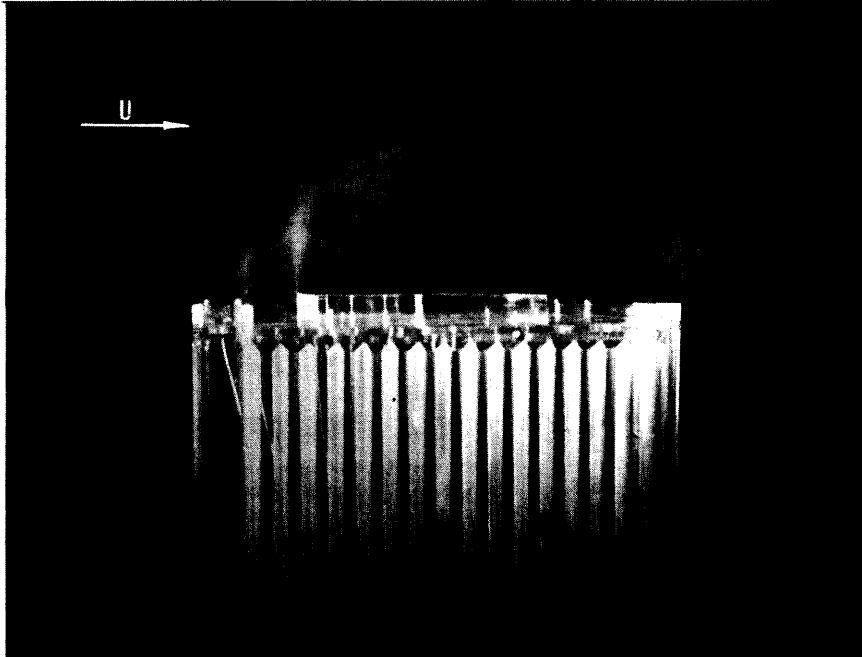
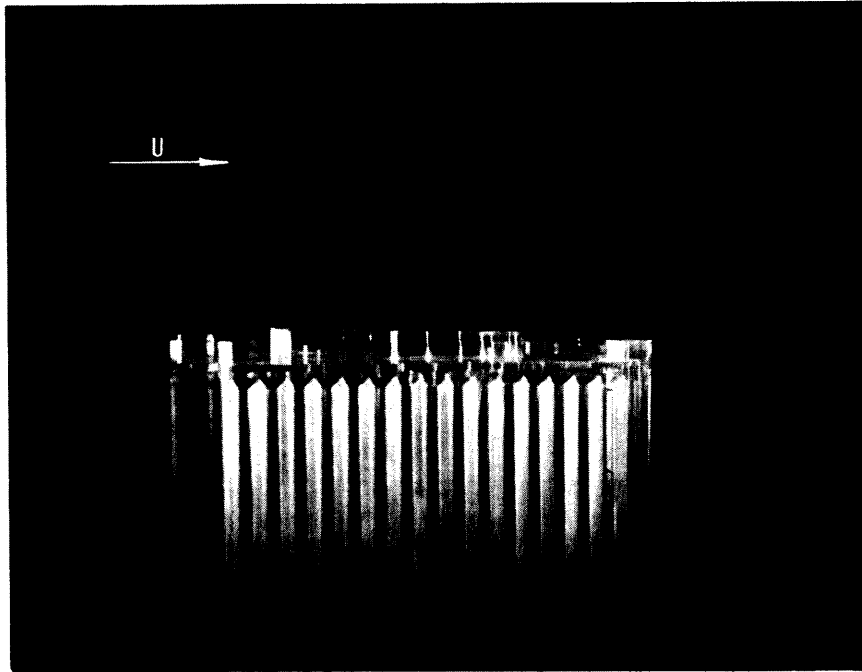

Fig. 3-7. Flow pattern on the roof $\alpha = 0$.

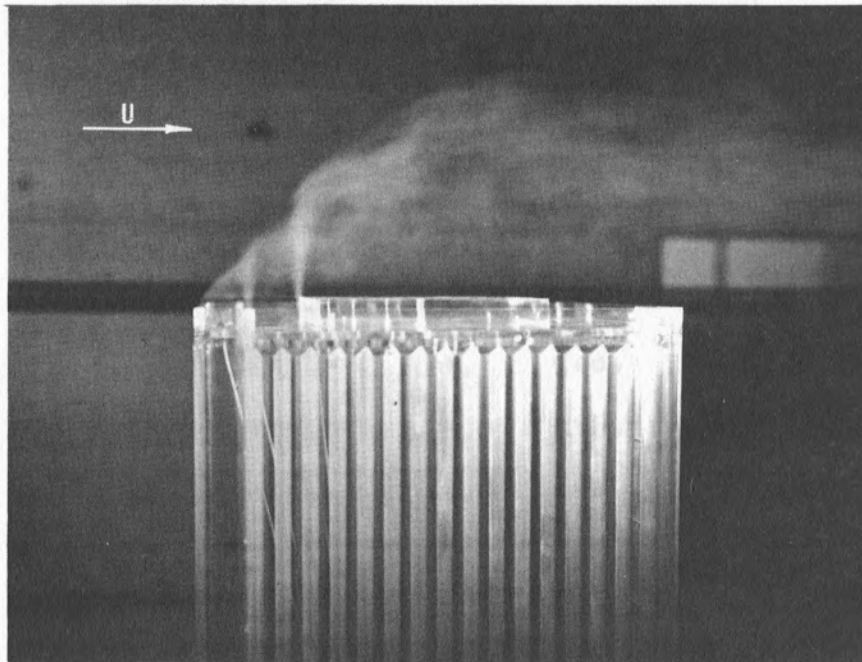
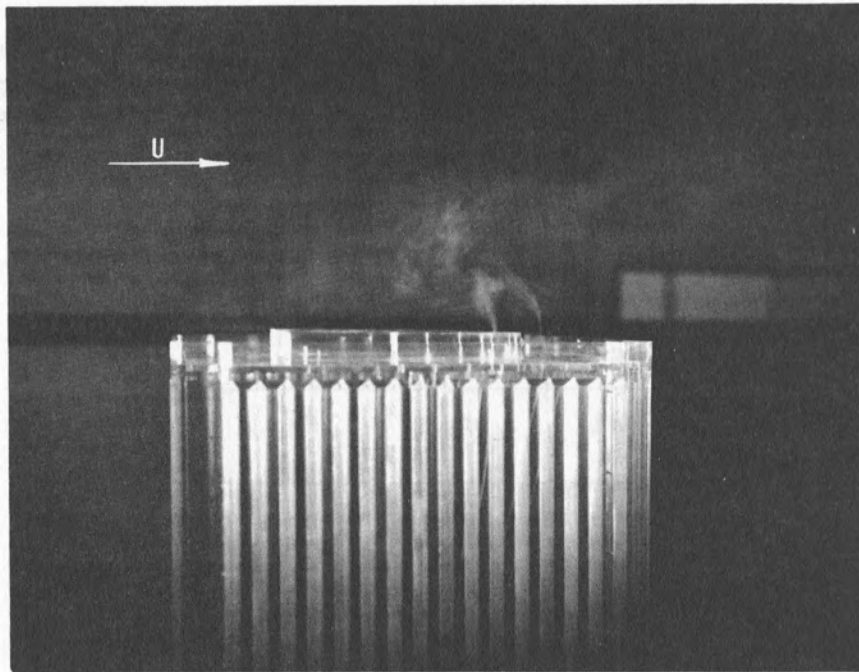

Fig. 3-7. Flow pattern on the roof $\alpha = 0$.

TABLE 1

MEAN PRESSURE COEFFICIENTS FOR POSITIONS--W1, B1A, F2A, D1, D2, D3, D4, C6, F1, F2, F3, F4, F5, F6, F7, F8, F9, F10, F11, F12, F13, F14, F15, F16 MEASURED WITH RESPECT TO FREE STREAM STATIC PRESSURE.

DYNAMIC HEAD = 0.84 MM OF HG.

DATE OF EXPERIMENT = SEPT. 2, 1970

ANGLES MEASURED IN DEGREES = -180 TO ZERO TO +170
POSITION OF TAP

AZIMUTH ANGLE	W1	B1	B1A	F1A
-180	-.974	-.948	-1.006	-.983
-170	-.750	-.519	-.560	-.916
-160	-.779	-.487	-.534	-.995
-150	-.820	-.525	-.490	-1.152
-140	-.674	-.373	-.341	-1.310
-130	-.627	-.347	-.303	-1.412
-120	-.330	-.009	.012	-1.248
-110	-.219	.111	.064	-1.277
-100	-.169	.143	.131	-2.115
-90	.105	.417	.385	-1.639
-80	.531	.642	.615	-.823
-70	.796	.875	.805	.137
-60	.907	.834	.863	.776
-50	.758	.782	.785	.928
-40	.245	.236	.213	.502
-30	-.379	-.333	-.373	-.088
-20	-1.041	-.942	-1.062	-.792
-10	-1.476	-1.377	-1.479	-1.222

TABLE 1 (cont'd)

POSITION OF TAP

AZIMUTH ANGLE	W_1	B_1	B_{1A}	F_{1A}
-5	-1.493	-1.330	-1.476	-1.251
-0	-1.248	-1.123	-1.205	-1.079
5	-1.181	-1.102	-1.097	-1.012
10	-.963	-.875	-.980	-.948
15	-1.006	-.928	-1.003	-1.187
20	-1.073	-.965	-1.088	-1.534
25	-1.105	-.986	-1.041	-1.458
30	-1.114	-1.012	-1.138	-1.350
40	-1.184	-1.044	-1.181	-1.333
50	-1.050	-.933	-1.027	-1.222
60	-.998	-.878	-.983	-1.111
70	-.951	-.828	-.928	-1.102
80	-.884	-.823	-.866	-1.059
90	-.799	-.706	-.808	-1.079
100	-1.035	-.872	-.974	-1.324
110	-1.100	-.983	-1.114	-1.537
120	-1.105	-1.047	-1.129	-1.336
130	-1.330	-1.237	-1.315	-1.447
140	-1.362	-1.330	-1.412	-1.438
150	-1.406	-1.289	-1.339	-1.441
160	-1.301	-1.152	-1.213	-1.324
170	-1.082	-1.021	-1.100	-1.172

TABLE 1 (cont'd)

DYNAMIC HEAD = 0.84 MM of HG.

DATE OF EXPERIMENT = Sept. 2, 1970

ANGLES MEASURED IN DEGREES = -40 to Zero to +32

POSITION OF TAP

AZIMUTH ANGLE	D1	D2	D3	D4
-40	-.292	-1.855	-1.444	-.373
-20	1.078	-.236	.400	.557
-15	.700	-.761	-.090	.452
-10	.175	-1.368	-.782	.140
-8	-.163	-1.733	-1.178	-.263
-6	-.264	-1.855	-1.292	-.274
-4	-.383	-2.004	-1.523	-.321
-2	-.394	-1.951	-1.552	-.452
-1	-.320	-1.849	-1.476	-.382
0	-.413	-1.902	-1.575	-.443
2	-.460	-1.995	-1.639	-.554
4	-.569	-2.120	-1.800	-.700
6	-.674	-2.217	-1.963	-.904
8	-.803	-2.400	-2.217	-1.172
10	-.901	-2.421	-2.246	-1.298
12	-1.050	-2.538	-2.409	-1.566
14	-1.048	-2.546	-2.447	-1.753
16	-.670	-1.992	-1.873	-1.543
18	-.385	-1.689	-1.628	-1.225
20	-.294	-1.654	-1.549	-1.105

TABLE 1 (cont'd)

POSITION OF TAP

AZIMUTH ANGLE	D1	D2	D3	D4
22	-.224	-1.523	-1.388	-.965
25	-.203	-1.523	-1.321	-.925
28	-.184	-1.546	-1.348	-.904
32	-.210	-1.537	-1.318	-.922

TABLE 1 (cont'd)

DYNAMIC HEAD = 0.84 MM of HG.

DATE OF EXPERIMENT = Sept. 2, 1970

ANGLES MEASURED IN DEGREES = -180 to Zero to +170

POSITION OF TAP

AZIMUTH ANGLE	C6	F1	F2	F3	F4	F5
-180	-1.079	-1.187	-1.132	-1.167	-1.260	-1.269
-170	-1.228	-1.368	-1.383	-1.234	-1.222	-1.199
-160	-1.447	-1.575	-1.581	-1.406	-1.426	-1.349
-150	-1.593	-1.735	-1.630	-1.479	-1.540	-1.437
-140	-1.499	-1.628	-1.595	-1.453	-1.517	-1.444
-130	-1.496	-1.555	-1.415	-1.388	-1.485	-1.416
-120	-1.499	-1.604	-1.313	-1.292	-1.237	-1.244
-105	-1.388	-1.534	-1.190	-1.073	-1.047	-1.015
-90	-1.158	-1.254	-1.047	-.963	-1.018	-1.027
-75	-1.102	-1.152	-1.135	-1.062	-1.053	-1.057
-60	-1.263	-1.383	-1.298	-1.260	-1.251	-1.220
-50	-1.380	-1.493	-1.397	-1.374	-1.461	-1.423
-40	-1.345	-1.476	-1.321	-1.330	-1.397	-1.384
-35	-1.342	-1.458	-1.263	-1.248	-1.324	-1.260
-30	-1.534	-1.657	-1.496	-1.502	-1.528	-1.426
-25	-1.388	-1.581	-1.327	-1.339	-1.368	-1.274
-20	-1.543	-1.633	-1.248	-1.237	-1.278	-1.230
-15	-2.348	-1.680	-1.324	-1.222	-1.301	-1.241
-10	-2.115	-1.199	-1.219	-1.167	-1.234	-1.206

TABLE 1 (cont'd)

POSITION OF TAP

AZIMUTH ANGLE	C6	F1	F2	F3	F4	F5
-5	-1.447	-.989	-1.260	-1.208	-1.222	-1.195
0	-.901	-1.015	-1.444	-1.397	-1.383	-1.332
5	-.668	-1.164	-1.832	-1.738	-1.741	-1.652
10	-.085	-.968	-1.753	-1.657	-1.663	-1.540
15	.146	-.820	-1.517	-1.482	-1.423	-1.283
20	.160	-.703	-1.403	-1.342	-1.272	-1.022
25	.309	-.330	-.936	-.928	-.890	-.607
30	.394	-.023	-.589	-.522	-.385	-.145
35	.563	.315	-.225	-.198	.190	.180
40	.747	.598	.140	.400	.490	.226
45	.863	.849	.461	.639	.481	.376
50	.957	1.035	.814	.741	.709	.553
60	.715	.747	.840	.782	.764	.679
70	.105	.053	.796	.858	.904	.800
80	-.758	-.840	.531	.802	.916	.847
90	-1.499	-1.572	.204	.572	.779	.735
100	-2.085	-2.240	-.248	.283	.510	.595
110	-1.502	-1.695	-.312	.076	.300	.359
120	-1.403	-1.502	-.566	-.198	.029	.124
130	-1.368	-1.575	-.735	-.397	-.175	-.103
140	-1.461	-1.528	-.939	-.662	-.499	-.411
150	-1.210	-1.278	-.916	-.718	-.575	-.530
160	-1.178	-1.237	-1.003	-.843	-.773	-.714
170	-1.047	-1.111	-.989	-.936	-.933	-.996

TABLE 1 (cont'd)

DYNAMIC HEAD = 0.84 MM of HG.

DATE OF EXPERIMENT = Sept. 2, 1970

ANGLES MEASURED IN DEGREES = -180 to Zero to +175

AZIMUTH ANGLE	POSITION OF TAP					
	F6	F7	F8	F9	F10	F11
-180	-1.388	-1.453	-1.403	-1.342	-1.333	-1.258
-170	-1.184	-1.280	-1.126	-1.094	-1.117	-.994
-160	-1.348	-1.380	-1.208	-1.102	-1.117	-1.092
-150	-1.362	-1.464	-1.391	-1.228	-1.263	-1.178
-140	-1.418	-1.508	-1.383	-1.301	-1.371	-1.260
-130	-1.418	-1.511	-1.342	-1.257	-1.266	-1.148
-120	-1.415	-1.394	-1.304	-1.225	-1.278	-1.155
-110	-1.120	-1.175	-1.065	-.986	-1.009	-.887
-90	-.893	-.913	-.895	-.823	-.834	-.772
-85	-.980	-1.073	-.928	-.881	-.898	-.849
-75	-1.015	-1.143	-1.062	-.898	-.971	-.901
-60	-1.301	-1.368	-1.292	-1.266	-1.275	-1.181
-45	-1.467	-1.525	-1.400	-1.339	-1.380	-1.265
-30	-1.283	-1.400	-1.278	-1.301	-1.283	-1.262
-20	-1.315	-1.368	-1.310	-1.254	-1.307	-1.153
-15	-1.254	-1.298	-1.278	-1.184	-1.213	-1.162
-10	-1.181	-1.307	-1.199	-1.132	-1.213	-1.129
-5	-1.339	-1.412	-1.348	-1.278	-1.324	-1.174
0	-1.517	-1.663	-1.490	-1.327	-1.368	-1.304

TABLE 1 (cont'd)

POSITION OF TAP

AZIMUTH ANGLE	F6	F7	F8	F9	F10	F11
5	-1.278	-1.353	-1.295	-1.210	-1.237	-1.099
10	-1.636	-1.473	-1.263	-1.059	-.881	-.737
15	-1.756	-1.814	-1.572	-1.426	-1.403	-1.185
20	-.723	-.467	-.365	-.277	-.359	-.404
30	.137	.061	-.044	-.050	-.085	-.173
40	.400	.432	.257	.245	.198	.079
50	.659	.653	.493	.467	.414	.287
60	.866	.928	.747	.703	.697	.534
70	.995	1.100	.919	.881	.881	.775
80	.907	1.021	.878	.840	.913	.826
90	.977	1.105	1.012	1.006	1.053	.978
100	.858	.957	.901	.916	.986	.947
110	.639	.764	.718	.796	.898	.828
120	.473	.537	.551	.630	.697	.716
130	.187	.289	.318	.417	.493	.504
140	-.105	-.053	-.006	.155	.187	.240
150	-.373	-.327	-.257	-.178	-.175	-.084
160	-.639	-.607	-.519	-.470	-.519	-.618
170	-.974	-1.079	-1.068	-1.100	-1.225	-1.237
175	-1.345	-1.473	-1.409	-1.412	-1.514	-1.444

TABLE 1 (cont'd)

DYNAMIC HEAD = 0.85 MM of HG.

DATE OF EXPERIMENT = Sept. 2, 1970

ANGLES MEASURED IN DEGREES = -180 to Zero to +170

AZIMUTH ANGLE	POSITION OF TAP				
	F12	F13	F14	F15	F16
-180	-1.444	-1.528	-1.309	-1.277	-1.346
-170	-1.136	-1.196	-1.196	-1.026	-1.150
-160	-1.291	-1.337	-1.190	-1.127	-1.182
-145	-1.421	-1.473	-1.366	-1.251	-1.286
-130	-1.297	-1.407	-1.283	-1.234	-1.265
-105	-1.211	-1.265	-1.170	-1.049	-1.173
-90	-.917	-.968	-.954	-.891	-.905
-75	-1.061	-1.090	-1.078	-.980	-1.064
-60	-1.326	-1.430	-1.323	-1.283	-1.369
-50	-1.372	-1.539	-1.363	-1.257	-1.326
-40	-1.493	-1.516	-1.476	-1.424	-1.507
-30	-1.343	-1.467	-1.349	-1.372	-1.453
-20	-1.447	-1.539	-1.479	-1.369	-1.433
-15	-1.303	-1.418	-1.363	-1.317	-1.355
-10	-1.167	-1.268	-1.190	-1.084	-1.199
-5	-1.260	-1.277	-1.208	-1.127	-1.176
0	-1.320	-1.311	-1.262	-1.066	-1.130
5	-1.231	-1.147	-1.000	-.847	-.839

TABLE 1 (cont'd)

POSITION OF TAP

AZIMUTH ANGLE	F12	F13	F14	F15	F16
10	-.747	-.752	-.634	-.666	-.672
20	-.306	-.406	-.481	-.450	-.625
30	-.190	-.288	-.372	-.438	-.640
40	.078	-.012	-.133	-.262	-.458
50	.352	.262	.078	-.058	-.303
60	.565	.470	.297	.124	-.147
70	.741	.761	.516	.349	.069
80	.925	.948	.738	.559	.190
90	1.032	1.095	.859	.663	.435
100	1.041	1.124	.948	.816	.692
110	.891	1.006	.865	.810	.813
120	.703	.787	.689	.695	.738
130	.553	.669	.574	.674	.735
140	.329	.369	.438	.242	.196
150	-.055	-.268	-.432	-.467	-.533
160	-.882	-1.069	-1.101	-1.141	-1.173
170	-1.502	-1.672	-1.554	-1.493	-1.554

TABLE 2

MEAN PRESSURE COEFFICIENTS FOR POSITIONS--F1,F2,F3,F4,F5,
F6,F7,F8,F9,F10,F11,F12,F13,F14,F15,F16 MEASURED WITH
RESPECT TO B1,B2,B3,B4,B5,B6,B7,B8,B9,B10,B11,B12,B13,B14,
B15,B16.

DYNAMIC HEAD = 0.84 MM OF HG.

DATE OF EXPERIMENT = August 31, 1970

ANGLES MEASURED IN DEGREES = +90 TO ZERO TO -90

POSITION OF TAP

AZIMUTH ANGLE	F1-B1	F2-B2	F3-B3	F4-B4	F5-B5	F6-B6
90	-2.068	-.580	-.155	-.149	-.076	-.140
80	-1.636	-.446	-.067	-.102	-.061	-.149
70	-.837	-.158	.053	-.012	-.003	-.086
60	-.248	-.044	.111	.029	.050	-.063
50	.093	.061	.225	.102	.120	.021
45	.239	-.207	.309	.029	.123	.005
40	.347	-.254	.006	.172	.064	.140
35	.414	-.067	-.263	.006	.152	-.005
30	.496	-.082	-.029	-.210	-.117	-.005
25	.563	-.155	-.067	-.219	-.166	-.156
20	.718	-.093	-.041	-.230	-.228	-.224
15	.718	-.140	-.035	-.190	-.219	-.317
5	.680	-.169	-.079	-.207	-.207	-.303
0	.481	-.172	.009	-.076	-.082	-.184
-5	.242	-.155	.038	-.064	-.067	-.184
-10	-.009	-.123	.012	-.067	-.050	-.159

TABLE 2 (cont'd)

POSITION OF TAP

AZIMUTH ANGLE	F1-B1	F2-B2	F3-B3	F4-B4	F5-B5	F6-B6
-15	-.335	-.076	.070	-.058	-.035	-.156
-20	-.254	-.090	.064	-.032	-.038	-.149
-25	-.178	-.070	-.035	-.053	-.053	-.177
-30	-.102	-.061	.070	-.006	-.015	-.149
-35	-.111	-.070	.041	-.038	-.064	-.177
-40	-.047	-.035	.070	-.044	-.020	-.133
-50	-.032	-.079	.032	-.070	-.070	-.142
-60	-.018	-.012	.079	-.038	-.015	-.124
-70	-.041	-.006	.102	-.006	.018	-.093
-80	-.038	-.038	.067	-.044	.009	-.117
-90	-.105	-.061	.020	-.105	-.055	-.114

TABLE 2 (cont'd)

DYNAMIC HEAD = 0.86 MM OF HG.

DATE OF EXPERIMENT = August 31, 1970

ANGLES MEASURED IN DEGREES = +90 TO ZERO TO -90

POSITION OF TAP						
AZIMUTH ANGLE	F7-B7	F8-B8	F9-B9	F10-B10	F11-B11	F12-B12
90	-.131	-.103	-.023	-.088	-.111	-.132
75	-.023	-.003	.088	.031	.009	-.014
60	.085	.100	.188	.103	.077	.036
50	.202	.199	.299	.217	.134	.100
45	.137	.168	.256	.154	.117	.130
40	.182	.205	.234	.191	.057	.107
35	.217	.219	.342	.188	.134	.082
30	.194	.205	.302	.174	.131	.030
25	.091	.194	.273	.188	.091	.071
20	-.066	.077	.197	.179	.108	.034
15	-.151	-.077	.091	.071	.083	-.014
10	-.188	-.194	-.037	-.068	-.085	-.144
5	-.068	-.051	.034	-.094	-.094	-.166
0	-.026	-.046	.031	-.123	-.054	-.196
-5	-.103	-.043	-.003	-.094	-.085	-.237
-10	.037	.080	.151	.057	.023	-.130
-15	.020	.034	.091	-.006	-.009	-.112
-20	.006	0.000	.123	-.003	-.046	-.137
-30	.009	.023	.105	-.006	-.006	-.107

TABLE 2 (cont'd)

POSITION OF TAP

AZIMUTH ANGLE	F7-B7	F8-B8	F9-B9	F10-B10	F11-B11	F12-B12
-40	-.068	-.068	.040	-.105	-.100	-.207
-50	-.006	.003	.088	-.028	-.043	-.144
-60	.040	.028	.120	.014	.020	-.137
-75	-.031	-.009	.043	-.034	-.037	-.134
-90	-.100	-.060	-.003	-.097	-.117	-.221

TABLE 2 (cont'd)

DYNAMIC HEAD = 0.86 MM OF HG.

DATE OF EXPERIMENT = August 31, 1970

ANGLES MEASURED IN DEGREES = +90 TO ZERO TO -90

POSITION OF TAP

AZIMUTH ANGLE	F13-B13	F14-B14	F15-B15	F16-B16
90	.123	.239	.587	2.057
85	.174	.279	.672	2.182
80	.182	.319	.672	2.171
75	.208	.348	.681	1.812
70	.248	.359	.593	1.407
65	.248	.376	.607	1.333
60	.199	.328	.618	1.165
55	.251	.376	.613	1.080
50	.268	.382	.570	.977
45	.282	.382	.573	.912
40	.228	.293	.536	.741
35	.162	.217	.382	.550
30	.234	.333	.453	.567
25	.231	.308	.402	.427
20	.165	.157	.291	.276
15	.202	.205	.248	.273
10	.071	.077	.202	.123
5	-.094	-.091	.046	.057
0	-.168	-.219	-.085	-.188

TABLE 2 (cont'd)

POSITION OF TAP

AZIMUTH ANGLE	F13-B13	F14-B14	F15-B15	F16-B16
-5	.031	-.037	.128	-.057
-10	-.006	.011	.114	-.009
-20	-.014	-.023	.031	-.085
-30	.066	.051	.211	-.011
-40	.037	-.009	.174	-.060
-50	.020	-.011	.111	.066
-60	.034	.054	.177	.117
-75	.057	.063	.168	.208
-90	-.020	-.040	.077	.094

TABLE 3

MEAN PRESSURES (LBS./S.FT.) FOR POSITIONS--W1,B1A,F2A,D1,D2,D3,D4,
C6,F1,F2,F3,F4,F5,F6,F7,F8,F9,F10,F11,F12,F13,F14,F15,F16 MEASURED
WITH RESPECT TO FREE STREAM STATIC PRESSURE.

DESIGN WIND SPEED = 120 M.P.H.

DYNAMIC HEAD = 0.84 MM OF HG.

DATE OF EXPERIMENT = September 2, 1970

ANGLES MEASURED IN DEGREES = -180 TO ZERO TO +170

POSITION OF TAP

AZIMUTH ANGLE	W1	B1	B1A	F1A
-180	-31.2	-30.4	32.2	31.5
-170	24.1	16.6	18.0	29.4
-160	25.0	15.6	17.1	31.9
-150	26.3	16.8	15.7	37.0
-140	21.6	12.0	10.9	42.0
-130	20.1	11.1	9.7	45.3
-120	10.6	.3	.4	40.0
-110	7.0	3.6	2.1	44.2
-100	5.4	4.6	4.2	67.8
- 90	3.4	13.4	12.4	52.6
- 80	17.0	20.6	19.7	26.4
- 70	25.5	25.8	25.8	4.4
- 60	29.1	26.8	27.7	24.9
- 50	24.3	25.1	25.2	29.8
- 40	7.9	7.6	6.8	16.1

TABLE 3 (cont'd)

AZIMUTH ANGLE	W1	B1	B1A	F1A
- 30	12.2	10.7	11.9	2.8
- 20	33.4	30.2	34.1	25.1
- 10	47.4	44.2	47.4	39.2
- 5	-47.9	42.7	47.4	40.1
0	-40.0	-36.0	-38.7	-34.6
5	-37.9	-35.4	-35.2	-32.5
10	-30.9	-28.1	-31.4	-30.4
15	-32.3	-29.8	-32.2	-38.1
20	-34.4	-31.0	34.9	49.2
25	35.4	31.6	33.4	46.8
30	35.7	32.5	36.5	45.3
40	37.9	33.5	37.9	42.8
50	33.7	29.9	32.9	39.2
60	32.0	28.2	31.5	35.6
70	30.5	26.6	29.8	35.4
80	28.4	26.4	27.8	33.4
90	25.6	22.6	25.9	34.6
100	33.2	28.0	31.2	42.5
110	35.3	31.5	35.7	49.3
120	35.4	33.6	36.2	42.9
130	42.7	39.7	42.2	46.4
140	43.7	42.7	45.3	46.1
150	45.1	41.4	43.0	46.2

TABLE 3 (cont'd)

AZIMUTH ANGLE	W1	B1	B1A	F1A
160	41.7	37.0	38.9	42.5
170	34.7	32.8	35.3	37.6
20	- 9.4	-53.1	-49.7	-35.5
22	- 7.2	-48.8	-44.5	-31.0
25	- 6.5	-48.8	-42.4	-29.7
28	- 5.9	-49.6	-43.2	-29.0
32	- 6.7	-49.3	-42.3	-29.6

TABLE 3 (cont'd)

DYNAMIC HEAD = 0.84 MM OF HG.

DATE OF EXPERIMENT = September 2, 1970

ANGLES MEASURED IN DEGREES = -40 TO ZERO TO +32

AZIMUTH ANGLE	POSITION OF TAP			
	D1	D2	D3	D4
-40	-9.4	-59.5	-46.3	-12.0
-20	34.6	-7.6	12.8	17.9
-15	22.5	-24.4	-2.9	14.5
-10	5.6	-43.9	-25.1	4.5
-8	-5.2	-55.6	-37.8	-8.4
-6	-8.5	-59.5	-41.5	-8.8
-4	-12.3	-64.3	-48.8	-10.3
-2	-12.7	-62.6	-49.8	-14.5
-1	-10.3	-59.3	-47.3	-12.3
0	-13.2	-61.0	-50.5	-14.2
2	-14.7	-64.0	-52.6	-17.8
4	-18.3	-68.0	-57.7	-22.5
6	-21.6	-71.1	-63.0	-29.0
8	-25.7	-77.0	-71.1	-37.6
10	-28.9	-77.7	-72.0	-41.6
12	-33.7	-81.4	-77.3	-50.2
14	-33.6	-81.7	-78.5	-56.2
16	-21.5	-63.9	-60.1	-49.5
18	-12.4	-54.2	-52.2	-39.3

TABLE 3 (cont'd)

POSITION OF TAP

AZIMUTH ANGLE	D1	D2	D3	D4
20	-9.4	-53.1	-49.7	-35.5
22	-7.2	-48.8	-44.5	-31.0
25	-6.5	-48.8	-42.4	-29.7
28	-5.9	-49.6	-43.2	-29.0
32	-6.7	-49.3	-42.3	-29.6

TABLE 3 (cont'd)
 DYNAMIC HEAD = 0.84 MM OF HG.
 DATE OF EXPERIMENT = September 2, 1970
 ANGLES MEASURED IN DEGREES = -180 TO ZERO TO +170

AZIMUTH ANGLE	POSITION OF TAP					
	C6	F1	F2	F3	F4	F5
-130	-34.6	-38.1	-36.3	-37.4	-40.4	-40.7
-170	-39.4	-43.9	-44.4	-39.6	-39.2	-38.5
-160	-46.4	-50.5	-50.7	-45.1	-45.8	-43.3
-150	-51.1	-55.7	-52.3	-47.4	-49.4	-46.1
-140	-48.1	-52.2	-51.2	-46.5	-48.7	-46.3
-130	-48.0	-49.9	-45.4	-44.5	-47.6	-45.4
-120	-48.1	-51.5	-42.1	-41.5	-39.7	-39.9
-105	-44.5	-49.2	-38.2	-34.4	-33.6	-32.6
-90	-37.1	-40.2	-33.6	-30.9	-32.7	-32.9
-75	-35.4	-37.0	-36.4	-34.1	-33.8	-33.9
-60	-40.5	-44.4	-41.6	-40.4	-40.1	-39.1
-50	-44.3	-47.9	-44.8	-44.1	-46.9	-45.7
-40	-43.1	-47.3	-42.4	-42.7	-44.8	-44.4
-35	-43.0	-46.8	-40.5	-40.0	-42.5	-40.4
-30	-49.2	-53.1	-48.0	-48.2	-49.0	-45.7
-25	-44.5	-50.7	-42.6	-42.9	-43.9	-40.9
-20	-49.5	-52.4	-40.0	-39.7	-41.0	-39.4
-15	-75.3	-53.9	-42.5	-39.2	-41.7	-39.8
-10	-67.8	-38.5	-39.1	-37.4	-39.6	-38.7
-5	-46.4	-31.7	-40.4	-38.7	-39.2	-33.3

TABLE 3 (cont'd)
POSITION OF TAP

AZIMUTH ANGLE	C6	F1	F2	F3	F4	F5
0	-28.9	-32.6	-46.3	-44.8	-44.4	-42.7
5	-21.4	-37.3	-58.8	-55.8	-55.9	-53.0
10	-2.7	-31.1	-56.2	-53.1	-53.3	-49.4
15	4.7	-26.3	-48.7	-47.5	-45.7	-41.2
20	5.1	-22.5	-45.0	-43.0	-40.8	-32.8
25	9.9	-10.6	-30.0	-29.8	-28.5	-19.5
30	12.6	-.7	-18.9	-16.7	-12.4	-4.6
35	18.1	10.1	-7.2	-6.4	6.1	5.8
40	24.0	19.2	4.5	12.8	15.7	7.3
45	27.7	27.2	14.8	20.5	15.4	12.1
50	30.7	33.2	26.1	23.8	22.7	17.7
60	22.9	24.0	26.9	25.1	24.5	21.8
70	3.4	1.7	25.5	27.5	29.0	25.7
80	-24.3	-26.9	17.0	25.7	29.4	27.2
90	-48.1	-50.4	6.5	18.3	25.0	23.6
100	-66.9	-71.9	-8.0	9.1	16.4	19.1
110	-48.2	-54.4	-10.0	2.4	9.6	11.5
120	-45.0	-48.2	-18.2	-6.4	.9	4.0
130	-43.9	-50.5	-23.6	-12.7	-5.6	-3.3
140	-46.9	-49.0	-30.1	-21.2	-16.0	-13.2
150	-38.8	-41.0	-29.4	-23.0	-18.4	-17.0
160	-37.8	-39.7	-32.2	-27.0	-24.8	-22.9
170	-33.6	-35.6	-31.7	-30.0	-29.9	-32.0

TABLE 3 (cont'd)

DYNAMIC HEAD = 0.84 MM OF HG.

DATE OF EXPERIMENT = September 2, 1970

ANGLES MEASURED IN DEGREES = -180 TO ZERO TO +175

AZIMUTH ANGLE	POSITION OF TAP					
	F6	F7	F8	F9	F10	F11
-180	-44.5	-46.6	-45.0	-43.0	-42.8	-40.3
-170	-38.0	-41.1	-36.1	-35.1	-35.8	-31.9
-160	-43.2	-44.3	-38.7	-35.4	-35.8	-35.0
-150	-43.7	-47.0	-44.6	-39.4	-40.5	-37.8
-140	-45.5	-48.4	-44.4	-41.7	-44.0	-40.4
-130	-45.5	-48.5	-43.0	-40.3	-40.6	-36.8
-120	-45.4	-44.7	-41.8	-39.3	-41.0	-37.1
-110	-35.9	-37.7	-34.2	-31.6	-32.4	-28.4
-90	-28.6	-29.3	-28.7	-26.4	-26.8	-24.8
-85	-31.4	-34.4	-29.8	-28.3	-28.8	-27.2
-75	-32.6	-36.7	-34.1	-28.8	-31.2	-28.9
-60	-41.7	-43.9	-41.5	-40.6	-40.9	-37.9
-45	-47.1	-48.9	-44.9	-42.9	-44.3	-40.6
-30	-41.2	-44.9	-41.0	-41.7	-41.2	-40.5
-20	-42.2	-43.9	-42.0	-40.2	-41.9	-37.0
-15	-40.2	-41.6	-41.0	-38.0	-38.9	-37.3
-10	-37.9	-41.9	-38.5	-36.3	-38.9	-36.2
-5	-42.9	-45.3	-43.2	-41.0	-42.5	-37.7
0	-48.7	-53.3	-47.8	-42.6	-43.9	-41.8

TABLE 3 (cont'd)

POSITION OF TAP						
AZIMUTH ANGLE	F6	F7	F8	F9	F10	F11
5	-41.0	-43.4	-41.5	-38.8	-39.7	-35.3
10	-52.5	-47.3	-40.5	-34.0	-28.3	-23.7
15	-56.3	-58.2	-50.4	-45.8	-45.0	-38.0
20	-23.2	-15.0	-11.7	-8.9	-11.5	-12.9
30	4.4	2.0	-1.4	-1.6	-2.7	-5.5
40	12.8	13.8	8.2	7.9	6.4	2.5
50	21.1	21.0	15.8	15.0	13.3	9.2
60	27.8	29.8	24.0	22.5	22.4	17.1
70	31.9	35.3	29.5	28.3	28.3	24.9
80	29.1	32.7	28.2	26.9	29.3	26.5
90	31.3	35.5	32.5	32.3	33.8	31.4
100	27.5	30.7	28.9	29.4	31.6	30.4
110	20.5	24.5	23.0	25.5	28.8	26.6
120	15.2	17.2	17.7	20.2	22.4	23.0
130	6.0	9.3	10.2	13.4	15.8	16.2
140	-3.4	-1.7	-.2	5.0	6.0	7.7
150	-12.0	-10.5	-8.2	-5.7	-5.6	-2.7
160	-20.5	-19.5	-16.7	-15.1	-16.7	-19.8
170	-31.3	-34.6	-34.2	-35.3	-39.3	-39.7
175	-43.1	-47.3	-45.2	-45.3	-48.6	-46.3

TABLE 3 (cont'd)
 DYNAMIC HEAD = 0.85 MM OF HG.
 DATE OF EXPERIMENT = September 2, 1970
 ANGLES MEASURED IN DEGREES = -180 TO ZERO TO +170

AZIMUTH ANGLE	POSITION OF TAP				
	F12	F13	F14	F15	F16
-180	-46.3	-49.0	-42.0	-41.0	-43.2
-170	-36.4	-38.4	-38.4	-32.9	-36.9
-160	-41.4	-42.9	-38.2	-36.2	-37.9
-145	-45.6	-47.3	-43.8	-40.1	-41.2
-130	-41.6	-45.1	-41.1	-39.6	-40.6
-105	-38.8	-40.6	-37.5	-33.7	-37.6
-90	-29.4	-31.1	-30.6	-28.6	-29.0
-75	-34.0	-35.0	-34.6	-31.4	-34.1
-60	-42.5	-45.9	-42.4	-41.1	-43.9
-50	-44.0	-49.4	-43.7	-40.3	-42.5
-40	-47.9	-48.6	-47.3	-45.7	-48.4
-30	-43.1	-47.1	-43.3	-44.0	-46.6
-20	-46.4	-49.4	-47.4	-43.9	-46.0
-15	-41.8	-45.5	-43.7	-42.3	-43.5
-10	-37.4	-40.7	-38.2	-34.8	-38.5
-5	-40.4	-41.0	-38.7	-36.2	-37.7
0	-42.3	-42.1	-40.5	-34.2	-36.2
5	-39.5	-36.8	-32.1	-27.2	-26.9
10	-23.9	-24.1	-20.3	-21.4	-21.5
20	-9.8	-13.0	-15.4	-14.4	-20.1

TABLE 3 (cont'd)

POSITION OF TAP

AZIMUTH ANGLE	F12	F13	F14	F15	F16
30	-6.1	-9.2	-11.9	-14.1	-20.5
40	2.5	-4.4	-4.3	-8.4	-14.7
50	11.3	8.4	2.5	-1.8	-9.7
60	18.1	15.1	9.5	4.0	-4.7
70	23.6	24.4	16.6	11.2	2.2
80	29.7	30.4	23.7	17.9	6.1
90	33.1	35.1	27.6	21.3	14.0
100	33.4	36.1	30.4	26.2	22.2
110	28.6	32.3	27.7	26.0	26.1
120	22.6	25.2	22.1	22.3	23.7
130	17.8	21.5	18.4	21.6	23.6
140	10.5	11.8	14.1	7.8	6.3
150	-1.8	-8.6	-13.9	-15.0	-17.1
160	-28.3	-34.3	-35.3	-36.6	-37.6
170	-48.2	-53.6	-49.8	-47.9	-49.8

TABLE 4

MEAN PRESSURES (LBS/S.FT.) FOR POSITIONS--F1,F2,F3,F4,F5,
F6,F7,F8,F9,F10,F11,F12,F13,F14,F15,F16 MEASURED WITH
RESPECT TO B1,B2,B3,B4,B5,B6,B7,B8,B9,B10,B11,B12,B13,B14,
B15,B16.

DESIGN WIND SPEED = 120 M.P.H.

DYNAMIC HEAD = 0.84 MM OF HG.

DATE OF EXPERIMENT= August 31, 1970

ANGLES MEASURED IN DEGREES =+90 TO ZERO TO -90

POSITION OF TAP						
AZIMUTH ANGLE	F1-B1	F2-B2	F3-B3	F4-B4	F5-B5	F6-B6
90	-66.3	-18.6	-5.0	-4.8	-2.43	-4.49
80	-52.5	-14.3	-2.2	-3.3	-1.96	-4.79
70	-26.9	-5.1	1.7	-.4	-.09	-2.77
60	-8.0	-1.4	3.6	.9	1.59	-2.02
50	3.0	2.0	7.2	3.3	3.84	.67
45	7.7	-6.6	9.9	.9	3.93	.15
40	11.1	-8.1	.2	5.5	2.06	4.49
35	13.3	-2.2	-8.4	.2	4.87	-.15
30	15.9	-2.6	-.9	-6.7	-3.74	-.15
25	18.1	-5.0	-2.2	-7.0	-5.33	-5.02
20	23.0	-3.0	-1.3	-7.4	-7.30	-7.19
15	23.0	-4.5	-1.1	-6.1	-7.02	-10.18
5	21.8	-5.4	-2.5	-6.6	-6.64	-9.73
0	15.4	-5.5	.3	-2.4	-2.62	-5.91
-5	7.8	-5.0	1.2	-2.1	-2.15	-5.91

TABLE 4 (cont'd)

POSITION OF TAP

AZIMUTH ANGLE	F1-B1	F2-B2	F3-B3	F4-B4	F5-B5	F6-B6
-10	-.3	-3.9	.4	-2.2	-1.59	-5.09
-15	-10.8	-2.4	2.2	-1.9	-1.12	-5.02
-20	-8.1	-2.9	2.1	-1.0	-1.22	-4.79
-25	-5.7	-2.2	-1.1	-1.7	-1.68	-5.69
-30	-3.3	-2.0	2.2	-.2	-.47	-4.79
-35	-3.6	-2.2	1.3	-1.2	-2.06	-5.69
-40	-1.5	-1.1	2.2	-1.4	-.65	-4.27
-50	-1.0	-2.5	1.0	-2.2	-2.25	-4.57
-60	-.6	-.4	2.5	-1.2	-.47	-3.97
-70	-1.3	-.2	3.3	-.2	.56	-2.99
-80	-1.2	-1.2	2.2	-1.4	.28	-3.74
-90	-3.4	-2.0	.7	-3.4	-1.78	-3.67

TABLE 4 (cont'd)

DYNAMIC HEAD = 0.86 MM OF HG.

DATE OF EXPERIMENT = August 31, 1970

ANGLES MEASURED IN DEGREES = +90 TO ZERO TO -90

AZIMUTH ANGLE	POSITION OF TAP					
	F7-B7	F8-B8	F9-B9	F10-B10	F11-B11	F12-B12
90	-4.2	-3.3	-.7	-2.8	-3.56	-4.24
75	-.7	-.1	2.8	1.0	.27	-.44
60	2.7	3.2	6.0	3.3	2.47	1.17
50	6.5	6.4	9.6	6.9	4.30	3.22
45	4.4	5.4	8.2	4.9	3.75	4.17
40	5.8	6.6	7.5	6.1	1.83	3.44
35	6.9	7.0	11.0	6.0	4.30	2.63
30	6.2	6.6	9.7	5.6	4.20	.95
25	2.9	6.2	8.8	6.0	2.92	2.27
20	-2.1	2.5	6.3	5.8	3.47	1.10
15	-4.8	-2.5	2.9	2.3	2.65	-.44
10	-6.0	-6.2	-1.2	-2.2	-2.74	-4.61
5	-2.2	-1.6	1.1	-3.0	-3.02	-5.34
0	-.8	-1.5	1.0	-3.9	-1.74	-6.29
-5	-3.3	-1.4	-.1	-3.0	-2.74	-7.60
-10	1.2	2.6	4.8	1.8	.73	-4.17
-15	.6	1.1	2.9	-.2	-.27	-3.58
-20	.2	0.0	3.9	-.1	-1.46	-4.39

TABLE 4 (cont'd)

POSITION OF TAP

AZIMUTH ANGLE	F7-B7	F8-B8	F9-B9	F10-B10	F11-B11	F12-B12
-30	.3	.7	3.4	-.2	-.18	-3.44
-40	-2.2	-2.2	1.3	-3.4	-3.20	-6.65
-50	-.2	.1	2.8	-.9	-1.37	-4.61
-60	11.9	10.8	12.5	8.0	9.64	11.48
-75	10.2	15.2	20.1	16.9	15.13	14.70
-90	8.8	8.7	7.7	5.0	6.99	7.46

TABLE 4 (cont'd)

DYNAMIC HEAD = 0.86 MM OF HG.

DATE OF EXPERIMENT = August 31, 1970

ANGLES MEASURED IN DEGREES = +90 TO ZERO TO -90

POSITION OF TAP				
AZIMUTH ANGLE	F13-B13	F14-B14	F15-B15	F16-B16
90	3.9	7.7	18.8	66.0
85	5.6	9.0	21.6	70.0
80	5.8	10.2	21.6	69.6
75	6.7	11.1	21.8	58.1
70	8.0	11.5	19.0	45.1
65	8.0	12.1	19.5	42.8
60	6.4	10.5	19.8	37.4
55	8.0	12.1	19.6	34.6
50	8.6	12.2	18.3	31.3
45	9.0	12.2	18.4	29.2
40	7.3	9.4	17.2	23.8
35	5.2	6.9	12.2	17.6
30	7.5	10.7	14.5	18.2
25	7.4	9.9	12.9	13.7
20	5.3	5.0	9.3	8.9
15	6.5	6.6	8.0	8.8
10	2.3	2.5	6.5	3.9
5	-3.0	-2.9	1.5	1.8

TABLE 4 (cont'd)

POSITION OF TAP				
AZIMUTH ANGLE	F13-B13	F14-B14	F15-B15	F16-B16
0	-5.4	-7.0	-2.7	-6.0
-5	1.0	-1.2	4.1	-1.8
-10	-.2	.4	3.7	-.3
-20	-.5	-.7	1.0	-2.7
-30	2.1	1.6	6.8	-.4
-40	1.2	-.3	5.6	-1.9
-50	.6	-.4	3.6	2.1
-60	1.1	1.7	5.7	3.7
-75	1.8	2.0	5.4	6.7
-90	-.6	-1.3	2.5	3.0

TABLE 5

Peak PRESSURE COEFFICIENTS FOR POSITIONS--W1, B1A, F2A, D1, D2, D3, D4, C6, F1, F2, F3, F4, F5, F6, F7, F8, F9, F10, F11, F12, F13, F14, F15, F16 MEASURED WITH RESPECT TO FREE STREAM STATIC PRESSURE.

DYNAMIC HEAD = 0.84 MM OF HG.

DATE OF EXPERIMENT = September 2, 1970

ANGLES MEASURED IN DEGREES = -180 TO ZERO TO +170

AZIMUTH ANGLE	POSITION OF TAP			
	W1	B1	B1A	F1A
-180	.856	.757	.888	.709
-170	.716	1.043	1.208	.799
-160	.467	.767	1.193	.617
-150	.392	.805	1.203	.541
-140	.343	.690	1.172	.615
-130	.359	.649	1.108	.435
-120	.254	.665	.960	.416
-110	.245	.592	.888	.427
-100	.299	.700	1.011	.369
-90	.216	.408	.764	.381
-80	.080	.246	.483	.258
-70	.064	.101	.101	.079
-60	.066	.071	.032	.057
-50	.057	.070	.061	.058
-40	.102	.096	.095	.085
-30	.067	.070	.083	.092

TABLE 5 (cont'd)

POSITION OF TAP

AZIMUTH ANGLE	W1	B1	B1A	F1A
-20	.086	.143	.149	.211
-10	.200	.160	.203	.270
-5	.211	.203	.181	.350
-0	.226	.223	.235	.360
5	.280	.268	.299	.430
10	.378	.303	.335	.595
15	.386	.404	.580	.957
20	.284	.324	.388	.798
25	.267	.235	.331	.790
30	.210	.223	.233	.554
40	.121	.125	.182	.411
50	.222	.258	.293	.300
60	.195	.217	.219	.289
70	.204	.197	.229	.261
80	.137	.201	.217	.260
90	.200	.308	.321	.443
100	.216	.203	.276	.576
110	.379	.426	.521	.774
120	.369	.261	.366	.938
130	.439	.309	.365	.359
140	.615	.521	.532	.694
150	.309	.413	.500	.378
160	.548	.544	.779	.468
170	.363	.389	.375	.349

TABLE 5 (cont'd)

DYNAMIC HEAD = 0.84 MM OF HG.

DATE OF EXPERIMENT = September 2, 1970

ANGLES MEASURED IN DEGREES = -40 TO ZERO TO +32

POSITION OF TAP				
AZIMUTH ANGLE	D1	D2	D3	D4
-40	.444	.394	.796	1.254
-20	.239	.445	.755	.736
-15	.358	.480	.805	1.012
-10	.460	.421	.906	1.127
-8	.446	.471	.935	1.361
-6	.505	.436	.878	1.324
-4	.448	.505	.933	1.383
-2	.594	.592	.796	1.180
-1	.500	.507	.798	1.298
0	.519	.518	.753	1.261
2	.527	.566	.895	1.348
4	.527	.509	.754	1.111
6	.511	.614	.818	1.461
8	.402	.451	.646	1.186
10	.481	.462	.645	1.076
12	.422	.598	.626	1.079
14	.325	.561	.634	1.078
16	.473	.598	.785	1.076
18	.466	.503	.706	.812

TABLE 5 (cont'd)

POSITION OF TAP

AZIMUTH ANGLE	D1	D2	D3	D4
20	.372	.384	.537	.655
22	.293	.311	.388	.553
25	.181	.219	.286	.477
28	.303	.303	.438	.508
32	.297	.299	.232	.289

TABLE 5 (cont'd)

DYNAMIC HEAD = 0.84 MM OF HG.

DATE OF EXPERIMENT = September 2, 1970

ANGLES MEASURED IN DEGREES = -180 TO ZERO TO +170

AZIMUTH ANGLE	POSITION OF TAP					
	C6	F1	F2	F3	F4	F5
-180	.601	.419	.987	.748	.964	.657
-170	.564	.419	.728	.774	.588	.596
-160	.707	.419	.522	.885	.435	.268
-150	.048	.419	.586	.516	.439	.391
-140	.043	.419	.473	.528	.551	.342
-130	.004	.419	.684	.461	.585	.476
-120	.417	.419	.445	.388	.423	.267
-105	.704	.419	.452	.328	.366	.454
-90	.512	.419	.296	.265	.198	.226
-75	.426	.419	.246	.213	.219	.285
-60	.257	.419	.239	.233	.203	.205
-50	.172	.419	.134	.112	.144	.138
-40	.233	.419	.214	.219	.191	.181
-35	.235	.419	.162	.159	.140	.145
-30	.319	.419	.300	.229	.286	.226
-25	.459	.419	.252	.240	.341	.216
-20	.421	.419	.214	.239	.248	.261
-15	.976	.419	.515	.386	.430	.357
-10	1.178	.419	.490	.384	.344	.361

TABLE 5 (cont'd)

POSITION OF TAP

AZIMUTH ANGLE	C6	F1	F2	F3	F4	F5
-5	1.432	.419	.481	.370	.330	.342
0	1.678	.419	.449	.400	.333	.301
5	1.630	.419	.430	.439	.362	.385
10	1.171	.419	.187	.251	.327	.293
15	.946	.419	.258	.299	.541	.593
20	.707	.419	.209	.481	.723	.569
25	.401	.419	.176	.273	.512	.583
30	.141	.419	.114	.241	.452	.599
35	.074	.419	.104	.381	.535	.607
40	.048	.419	.134	.405	.404	.429
45	.067	.419	.163	.207	.299	.272
50	.044	.419	.079	.149	.171	.174
60	.050	.419	.069	.067	.095	.107
70	.298	.419	.085	.082	.067	.043
80	.245	.419	.062	.076	.080	.037
90	.405	.419	.155	.121	.066	.091
100	.454	.419	.239	.115	.086	.089
110	.335	.419	.184	.155	.120	.112
120	.273	.419	.155	.115	.104	.097
130	.330	.419	.260	.223	.175	.219
140	.206	.419	.263	.209	.210	.157
150	.325	.419	.478	.351	.357	.363
160	.411	.419	.515	.578	.531	.546
170	.664	.419	.720	.538	.734	.584

TABLE 5 (cont'd)

DYNAMIC HEAD = 0.84 MM OF HG.

DATE OF EXPERIMENT = September 2, 1970

ANGLES MEASURED IN DEGREES = -180 TO ZERO TO +175

AZIMUTH ANGLE	POSITION OF TAP					
	F6	F7	F8	F9	F10	F11
-180	.884	.707	.626	.509	.376	.370
-170	.843	.356	.379	.363	.357	.247
-160	.483	.610	.735	.439	.560	.400
-150	.486	.265	.311	.245	.263	.259
-140	.255	.426	.338	.233	.308	.180
-130	.557	.500	.556	.408	.391	.331
-120	.478	.576	.353	.337	.331	.237
-110	.388	.359	.368	.410	.338	.352
-90	.258	.193	.283	.362	.442	.202
-85	.159	.220	.166	.197	.244	.231
-75	.254	.195	.245	.236	.273	.332
-60	.258	.252	.267	.238	.283	.216
-45	.158	.232	.159	.175	.211	.235
-30	.263	.207	.203	.172	.155	.114
-20	.379	.375	.267	.260	.217	.228
-15	.416	.480	.426	.499	.627	.499
-10	.353	.414	.436	.360	.414	.319
-5	.289	.417	.386	.344	.366	.338
0	.439	.452	.389	.394	.379	.453

TABLE 5 (cont'd)

POSITION OF TAP

AZIMUTH ANGLE	F6	F7	F8	F9	F10	F11
5	.318	.410	.312	.349	.370	.347
10	.589	.750	.802	.833	.965	1.249
15	.486	.509	.547	.621	.611	.735
20	.891	1.044	.961	.893	1.130	.959
30	.637	.855	.646	.824	.701	.543
40	.410	.335	.497	.458	.505	.490
50	.201	.286	.277	.290	.416	.450
60	.156	.113	.131	.146	.241	.301
70	.061	.083	.088	.140	.166	.187
80	.060	.071	.083	.069	.086	.096
90	.054	.060	.073	.058	.073	.072
100	.054	.050	.058	.067	.071	.064
110	.064	.076	.053	.071	.077	.063
120	.106	.077	.073	.069	.106	.085
130	.095	.102	.083	.089	.111	.090
140	.168	.111	.134	.125	.150	.115
150	.314	.335	.337	.410	.350	.412
160	.649	.642	.665	.729	.729	.576
170	.840	.917	.833	.407	.448	.369
175	.674	.582	.545	.432	.470	.398

TABLE 5 (cont'd)

DYNAMIC HEAD = 0.85 MM OF HG.

DATE OF EXPERIMENT = September 2, 1970

ANGLES MEASURED IN DEGREES = -180 TO ZERO TO +170

POSITION OF TAP					
AZIMUTH ANGLE	F12	F13	F14	F15	F16
-180	.405	.503	.389	.355	.318
-170	.350	.365	.274	.239	.357
-160	.330	.316	.225	.233	.424
-145	.238	.229	.171	.140	.213
-130	.294	.266	.206	.189	.218
-105	.329	.318	.336	.248	.258
-90	.264	.342	.282	.287	.378
-75	.401	.546	.470	.455	.679
-60	.239	.388	.321	.359	.480
-50	.284	.278	.304	.293	.478
-40	.404	.404	.414	.555	.514
-30	.297	.406	.208	.491	.272
-20	.388	.461	.471	.451	.438
-15	.431	.546	.357	.363	.366
-10	.556	.408	.343	.519	.385
-5	.388	.522	.460	.424	.380
0	.667	.948	.673	.558	.774
5	.924	.966	1.095	1.062	1.242
10	1.196	1.234	1.190	1.108	1.035

TABLE 5 (cont'd)

POSITION OF TAP

AZIMUTH ANGLE	F12	F13	F14	F15	F16
20	1.015	1.151	1.104	1.002	.986
30	.787	.793	.842	.855	.770
40	.454	.813	.618	.598	.894
50	.425	.588	.539	.556	.846
60	.367	.380	.510	.434	.752
70	.238	.329	.447	.409	.866
80	.136	.215	.320	.457	.725
90	.058	.094	.197	.326	.575
100	.046	.048	.065	.186	.349
110	.046	.086	.045	.045	.148
120	.056	.026	.026	.029	.053
130	.071	.073	.053	.056	.063
140	.141	.134	.196	.212	.071
150	.437	.419	.346	.066	.061
160	.551	.412	.313	.134	.124
170	.493	.378	.268	.220	.210

TABLE 6
 PEAK PRESSURE COEFFICIENTS FOR POSITIONS--F1,F2,F3,F4,F5,
 F6,F7,F8,F9,F10,F11,F12,F13,F14,F15,F16 MEASURED WITH
 RESPECT TO B1,B2,B3,B4,B5,B6,B7,B8,B9,B10,B11,B12B13,B14,B15,B16.

DYNAMIC HEAD = 0.84 MM OF HG.

DATE OF EXPERIMENT = August 31, 1970

ANGLES MEASURED IN DEGREES = +90 TO ZERO TO -90

AZIMUTH ANGLE	POSITION OF TAP					
	F1-B1	F2-B2	F3-B3	F4-B4	F5-B5	F6-B6
90	.633	.254	.137	.080	.055	.048
80	.446	.134	.063	.044	.048	.032
70	.168	.036	.031	.042	.044	.042
60	.028	.032	.038	.066	.099	.105
50	.045	.117	.131	.172	.146	.168
45	.051	.139	.216	.246	.289	.239
40	.044	.214	.518	.340	.389	.332
35	.042	.201	.483	.458	.567	.459
30	.066	.203	.532	.777	.930	.743
25	.114	.152	.351	.750	.830	.775
20	.230	.268	.595	.621	.909	.775
15	.195	.254	.378	.487	.531	.765
5	.295	.284	.386	.362	.448	.482
0	.532	.365	.322	.263	.305	.358
-5	.618	.432	.241	.171	.206	.176
-10	.783	.420	.219	.144	.300	.200

TABLE 6 (cont'd)

POSITION OF TAP

AZIMUTH ANGLE	F1-B1	F2-B2	F3-B3	F4-B4	F5-B5	F6-B6
-15	1.054	.410	.223	.236	.169	.157
-20	.677	.191	.181	.207	.225	.228
-25	.273	.191	.184	.169	.216	.251
-30	.375	.121	.150	.178	.191	.162
-35	.248	.125	.141	.201	.191	.141
-40	.207	.287	.265	.168	.235	.286
-50	.286	.102	.191	.137	.245	.255
-60	.207	.421	.261	.274	.309	.245
-70	.312	.238	.241	.226	.281	.216
-80	.528	.209	.303	.206	.334	.255
-90	.394	.316	.324	.316	.381	.201

TABLE 6 (cont'd)

DYNAMIC HEAD = 0.86 MM OF HG.

DATE OF EXPERIMENT = August 31, 1970

ANGLES MEASURED IN DEGREES = +90 TO ZERO TO -90

POSITION OF TAP

AZIMUTH ANGLE	F7-B7	F8-B8	F9-B9	F10-B10	F11-B11	F12-B12
90	.048	.057	.054	.054	.068	.079
75	.040	.050	.074	.098	.131	.162
60	.151	.174	.201	.272	.315	.352
50	.272	.242	.197	.322	.349	.367
45	.289	.359	.375	.369	.383	.472
40	.332	.479	.426	.434	.459	.528
35	.464	.550	.594	.479	.570	.561
30	.779	.722	.660	.644	.660	.791
25	1.081	1.060	1.064	.842	.741	.880
20	1.134	1.342	1.214	1.112	.919	1.022
15	1.140	1.269	1.187	1.192	1.211	1.137
10	.725	.795	.956	1.037	1.030	1.092
5	.588	1.081	.568	.738	1.105	1.427
0	.339	.678	.523	.584	.481	.624
-5	.298	.315	.405	.443	.466	.536
-10	.252	.367	.385	.420	.470	.516
-15	.412	.476	.607	.453	.544	.477
-20	.207	.182	.238	.392	.397	.401
-30	.362	.446	.422	.397	.365	.561

TABLE 6 (cont'd)

POSITION OF TAP

AZIMUTH ANGLE	F7-B7	F8-B8	F9-B9	F10-B-10	F11-B11	F12-B12
-40	.248	.254	.367	.453	.407	.393
-50	.266	.311	.238	.439	.221	.252
-60	.370	.338	.390	.248	.301	.358
-75	.319	.473	.625	.527	.471	.458
-90	.273	.271	.241	.155	.218	.232

TABLE 6 (cont'd)

DYNAMIC HEAD = 0.86 MM OF H₂O

DATE OF EXPERIMENT = August 31, 1970

ANGLES MEASURED IN DEGREES = +90 TO ZERO TO -90

POSITION OF TAP

AZIMUTH ANGLE	F13-B13	F14-B14	F15-B15	F16-B16
90	.100	.191	.305	.662
85	.135	.261	.355	.909
80	.172	.289	.427	.714
75	.178	.322	.399	.947
70	.194	.319	.392	.645
65	.295	.382	.504	.785
60	.306	.473	.450	.838
55	.355	.490	.624	.848
50	.406	.490	.621	.820
45	.466	.681	.799	.905
40	.415	.672	.667	.773
35	.600	.658	.701	.759
30	.672	.742	.751	1.014
25	.991	1.102	.912	.791
20	1.047	1.155	1.028	1.018
15	.967	1.262	1.131	1.494
10	1.481	1.132	1.051	1.682
5	1.508	1.471	1.168	1.430
0	.850	1.098	.843	1.038

TABLE 6 (cont'd)

POSITION OF TAP

AZIMUTH ANGLE	F13-B13	F14-B14	F15-B15	F16-B16
-5	.506	.548	.444	.295
-10	.231	.432	.215	.363
-20	.211	.291	.355	.557
-30	.449	.379	.420	.611
-40	.570	.601	.688	.561
-50	.218	.309	.499	.843
-60	.339	.392	.426	.510
-75	.312	.432	.375	.594
-90	.189	.308	.399	.490

TABLE 7

PEAK PRESSURES (LBS./S.FT.) FOR POSITIONS--W1,B1A,F2A,D1,D2,D3,D4,C6,
F1,F2,F3,F4,F5,F6,F7,F8,F9,F10,F11,F12,F13,F14,F15,F16 MEASURED WITH
RESPECT TO FREE STREAM STATIC PRESSURE.

DESIGN WIND SPEED = 120 M.P.H.

DYNAMIC HEAD = 0.84 MM OF HG.

DATE OF EXPERIMENT = September 2, 1970

ANGLES MEASURED IN DEGREES = -180 to ZERO TO +170

POSITION OF TAP

AZIMUTH ANGLE	W1	B1	B1A	F1A
-180	27.46	24.28	28.48	22.74
-170	22.96	33.46	38.75	25.63
-160	14.98	24.60	38.27	19.79
-150	12.57	25.82	38.59	17.35
-140	11.00	22.14	37.60	19.73
-130	11.52	20.82	35.54	13.95
-120	8.15	21.33	30.80	13.35
-110	7.86	18.99	28.49	13.70
-100	9.59	22.46	32.43	11.84
- 90	6.93	13.09	24.51	12.22
- 80	2.57	7.89	15.49	8.28
- 70	2.05	3.24	3.24	2.53
- 60	2.12	2.28	1.03	1.83
- 50	1.83	2.25	1.96	1.86
- 40	3.27	3.08	3.05	2.73

TABLE 7 (cont'd)

AZIMUTH ANGLE	W1	B1	B1A	F1A
- 30	2.15	2.25	2.66	2.95
- 20	2.76	4.59	4.78	6.77
- 10	6.42	5.13	6.51	8.66
- 5	6.77	6.51	5.81	11.22
0	7.25	7.15	7.54	11.54
5	8.98	8.60	9.59	13.79
10	12.13	9.72	10.75	19.09
15	12.38	12.96	18.61	30.70
20	9.11	10.39	12.45	25.60
25	8.57	7.54	10.62	25.34
30	6.74	7.15	7.47	17.77
40	3.88	4.01	5.84	13.18
50	7.12	8.28	9.40	9.62
60	6.26	6.96	7.03	9.27
70	6.54	6.32	7.35	8.37
80	4.39	6.45	6.96	8.34
90	6.42	9.88	10.30	14.21
100	6.93	6.51	8.85	18.47
110	12.16	13.67	16.71	24.83
120	11.84	8.37	11.74	30.09
130	14.08	9.91	11.71	11.52
140	19.73	16.71	17.07	22.26
150	9.91	13.25	16.04	12.13

TABLE 7 (cont'd)

AZIMUTH ANGLE	W1	B1	B1A	F1A
160	17.58	17.45	24.99	15.01
170	11.65	12.48	12.03	11.20

TABLE 7 (cont'd)

DYNAMIC HEAD = 0.84 MM OF HG.

DATE OF EXPERIMENT = September 2, 1970

ANGLES MEASURED IN DEGREES = -40 TO ZERO TO +32

AZIMUTH ANGLE	POSITION OF TAP			
	D1	D2	D3	D4
-40	14.26	12.63	25.54	40.23
-20	7.67	14.27	24.23	23.63
-15	11.49	15.39	25.82	32.47
-10	13.47	13.52	29.05	36.16
-8	14.30	15.11	29.99	43.65
-6	16.21	13.99	28.16	42.48
-4	14.37	16.19	29.94	44.35
-2	18.08	18.99	25.54	37.85
-1	16.06	19.46	25.59	41.64
0	16.65	16.61	24.14	40.47
2	16.92	18.15	28.72	43.23
4	16.92	16.33	24.19	35.65
6	16.39	19.70	26.25	46.88
8	12.91	14.46	20.73	38.03
10	15.42	14.83	20.68	34.53
12	13.55	19.18	20.07	34.62
14	10.44	18.01	20.35	34.57
16	15.16	19.18	25.17	34.53
18	14.93	16.14	22.64	26.06

TABLE 7 (cont'd)

POSITION OF TAP

AZIMUTH ANGLE	D1	D2	D3	D4
20	14.94	12.30	17.22	21.01
22	9.39	9.96	12.44	17.73
25	5.80	7.02	9.17	15.30
28	9.73	9.73	14.04	16.28
32	9.54	9.59	7.44	9.26

TABLE 7 (cont'd)
 DYNAMIC HEAD = 0.84 MM OF HG.

DATE OF EXPERIMENT = September 2, 1970

ANGLES MEASURED IN DEGREES = -180 TO ZERO TO +170

AZIMUTH ANGLE	POSITION OF TAP					
	C6	F1	F2	F3	F4	F5
-180	19.27	13.43	31.67	24.00	30.92	21.07
-170	18.11	13.43	23.34	24.84	18.85	19.13
-160	22.69	13.43	16.75	28.40	13.94	8.61
-150	20.77	13.43	18.81	16.56	14.08	12.54
-140	20.63	13.43	15.16	16.94	17.68	10.97
-130	19.37	13.43	21.94	14.78	18.76	15.27
-120	13.38	13.43	14.27	12.44	13.57	8.57
-105	22.60	13.43	14.50	10.53	11.74	14.56
-90	16.42	13.43	9.50	8.51	6.36	7.26
-75	13.66	13.43	7.91	6.83	7.02	9.13
-60	8.23	13.43	7.67	7.49	6.50	6.59
-50	5.52	13.43	4.30	3.60	4.63	4.42
-40	7.49	13.43	6.88	7.02	6.13	5.80
-35	7.53	13.43	5.19	5.10	4.49	4.64
-30	10.25	13.43	9.64	7.34	9.17	7.26
-25	14.74	13.43	8.09	7.91	10.95	6.92
-20	13.52	13.43	6.88	7.67	7.95	8.38
-15	31.30	13.43	16.51	12.40	13.80	11.45
-10	37.80	13.43	15.72	12.30	11.04	11.56
-5	45.94	13.43	15.44	11.88	10.57	10.97

TABLE 7 (cont'd)
POSITION OF TAP

AZIMUTH ANGLE	C6	F1	F2	F3	F4	F5
0	50.62	13.43	14.41	12.82	10.67	9.66
5	52.30	13.43	13.80	14.08	11.60	12.35
10	37.57	13.43	5.99	8.05	10.48	9.39
15	30.36	13.43	8.28	9.59	17.36	19.01
20	22.69	13.43	6.69	15.44	23.20	18.26
25	12.87	13.43	5.66	8.75	16.42	18.71
30	4.54	13.43	3.65	7.72	14.50	19.20
35	2.39	13.43	3.32	12.21	17.17	19.46
40	1.54	13.43	4.30	13.01	12.96	13.77
45	2.15	13.43	5.24	6.64	9.59	8.72
50	1.40	13.43	2.53	4.77	5.47	5.58
60	1.59	13.43	2.20	2.15	3.04	3.44
70	9.54	13.43	2.71	2.62	2.15	1.38
80	7.86	13.43	2.62	2.43	2.57	1.20
90	13.01	13.43	4.96	3.88	2.11	2.92
100	14.55	13.43	7.67	3.70	2.76	2.84
110	10.75	13.43	5.89	4.96	3.84	3.59
120	8.75	13.43	4.96	3.70	3.32	3.11
130	10.57	13.43	8.33	7.16	5.61	7.04
140	6.60	13.43	8.42	6.69	6.74	5.05
150	10.43	13.43	15.34	11.27	11.46	11.64
160	13.19	13.43	16.51	18.53	17.03	17.52
170	21.29	13.43	23.11	17.26	23.53	18.75

TABLE 7 (cont'd)

DYNAMIC HEAD = 0.84 MM OF HG.

DATE OF EXPERIMENT = September 2, 1970

ANGLES MEASURED IN DEGREES = -180 TO ZERO TO +175

AZIMUTH ANGLE	POSITION OF TAP					
	F6	F7	F8	F9	F10	F11
-180	28.35	22.69	20.07	16.33	12.07	11.86
-170	20.63	11.42	12.16	11.65	11.46	7.93
-160	15.49	19.56	23.58	14.08	17.96	12.84
-150	15.58	8.51	9.96	7.86	8.42	8.31
-140	8.19	13.66	10.85	7.49	9.87	5.76
-130	17.87	16.05	17.82	13.10	12.54	10.63
-120	15.34	18.48	11.32	10.81	10.62	7.60
-110	12.44	11.51	11.79	13.15	10.85	11.30
-90	8.28	6.18	9.08	11.60	14.18	6.47
-85	5.10	7.06	5.33	6.32	7.81	7.41
-75	8.14	6.27	7.86	7.58	8.75	10.67
-60	8.28	8.09	8.56	7.63	9.08	6.92
-45	5.05	7.44	5.10	5.61	6.78	7.52
-30	8.42	6.64	6.50	5.52	4.96	3.67
-20	12.16	12.02	8.56	8.33	6.97	7.30
-15	13.33	15.39	13.66	16.00	20.12	16.02
-10	11.32	13.29	13.99	11.56	13.29	10.22

TABLE 7 (cont'd)

POSITION OF TAP

AZIMUTH ANGLE	F6	F7	F8	F9	F10	F11
-5	9.26	13.38	12.40	11.04	11.74	10.85
0	14.08	14.50	12.49	12.63	12.16	14.52
5	10.20	13.15	10.01	11.18	11.88	11.12
10	18.90	24.05	25.73	26.71	30.97	40.08
15	15.58	16.33	17.54	19.93	19.60	23.58
20	28.58	33.50	30.83	28.63	36.26	30.76
30	20.44	27.42	20.73	26.43	22.50	17.40
40	13.15	10.76	15.95	14.69	16.19	15.72
50	6.46	9.17	8.89	9.31	13.33	14.45
60	5.01	3.79	4.21	4.68	7.72	9.66
70	1.96	2.67	2.81	4.49	5.33	5.99
80	1.92	2.29	2.67	2.20	2.76	3.14
90	1.73	1.92	2.34	1.87	2.34	2.32
100	1.73	1.59	1.87	2.15	2.29	2.06
110	2.06	2.43	1.68	2.29	2.48	2.02
120	3.42	2.48	2.34	2.20	3.42	2.73
130	3.04	3.27	2.67	2.85	3.56	2.88
140	5.38	3.56	4.30	4.02	4.82	3.71
150	10.06	10.76	10.81	13.15	11.23	13.21
160	20.82	20.58	21.33	23.39	23.39	18.49
170	26.95	29.43	26.71	13.05	14.36	11.83
175	21.61	18.67	17.50	13.85	15.06	12.76

TABLE 7 (cont'd)
 DYNAMIC HEAD = 0.85 MM OF HG.

DATE OF EXPERIMENT = September 2, 1970

ANGLES MEASURED IN DEGREES = -180 TO ZERO TO +170

AZIMUTH ANGLE	POSITION OF TAP				
	F12	F13	F14	F15	F16
-180	12.99	16.14	12.48	11.37	10.22
-170	11.23	11.70	8.78	7.67	11.47
-160	10.59	10.13	7.21	7.49	13.59
-145	7.63	7.35	5.50	4.48	6.84
-130	9.43	8.60	6.61	6.06	6.98
-105	10.54	10.22	10.77	7.95	8.28
-90	8.46	10.96	9.06	9.20	12.11
-75	12.85	17.52	15.07	14.61	21.78
-60	7.67	12.44	10.31	11.51	15.40
-50	9.11	8.92	9.76	9.39	15.35
-40	12.95	12.95	13.27	17.80	16.51
-30	9.52	13.04	6.66	15.77	8.74
-20	12.44	14.79	15.12	14.47	14.05
-15	13.82	17.52	11.47	11.65	11.74
-10	17.85	13.08	11.00	16.64	12.34
-5	12.44	16.74	14.75	13.59	12.21
0	21.41	30.42	21.59	17.89	24.83
5	29.64	30.98	35.14	34.07	39.85
10	38.37	39.58	38.19	35.55	33.20
20	32.55	36.94	35.41	32.13	31.62

TABLE 7 (cont'd)

POSITION OF TAP

AZIMUTH ANGLE	F12	F13	F14	F15	F16
30	25.24	25.43	27.00	27.42	24.69
40	14.56	26.08	19.83	19.19	28.66
50	13.64	18.86	17.29	17.85	27.14
60	11.79	12.21	16.37	13.92	24.13
70	7.63	10.54	14.33	13.13	27.79
80	4.44	6.89	10.26	14.66	23.26
90	1.85	3.01	6.33	10.45	18.45
100	1.48	1.53	2.08	5.96	11.19
110	1.48	2.77	1.43	1.43	4.76
120	1.80	.83	.83	.92	1.71
130	2.27	2.36	1.71	1.80	2.03
140	4.53	4.30	6.29	6.80	2.27
150	14.01	13.45	11.10	2.13	1.94
160	17.66	13.22	10.03	4.30	3.98
170	15.81	12.11	8.60	7.07	6.75

TABLE 8

PEAK PRESSURES (LBS./S.FT.) FOR POSITIONS--F1,F2,F3,F4,F5,F6,F7,F8,F9,
F10,F11,F12,F13,F14,F15,F16 MEASURED WITH RESPECT TO B1,B2,B3,B4,B5,
B6,B7,B8,B9,B10,B11,B12,B13,B14,B15,B16.

DESIGN WIND SPEED = 120 M.P.H.

DYNAMIC HEAD = 0.84 MM OF HG.

DATE OF EXPERIMENT= August 31, 1970

ANGLES MEASURED IN DEGREES=+90 TO ZERO TO -90

POSITION OF TAP						
AZIMUTH ANGLE	F1-B1	F2	F3-B3	F4-B4	F5-B5	F6-B6
90	20.3	8.1	4.4	2.6	1.78	1.53
80	14.3	4.3	2.0	1.4	1.54	1.01
70	5.4	1.2	1.0	1.4	1.40	1.35
60	.9	1.0	1.2	2.1	3.18	3.37
50	1.5	3.7	4.2	5.5	4.68	5.39
45	1.6	4.4	6.9	7.9	9.26	7.67
40	1.4	6.9	16.6	10.9	12.49	10.67
35	1.4	6.5	15.5	14.7	18.20	14.71
30	2.1	6.5	17.1	24.9	29.85	23.84
25	3.6	4.9	11.3	24.0	26.62	24.85
20	7.4	8.6	19.1	19.9	29.15	24.85
15	6.3	8.1	12.1	15.6	17.03	24.55
5	9.5	9.1	12.4	11.6	14.36	15.46
0	17.1	11.7	10.3	8.4	9.78	11.49

TABLE 8 (cont'd)
POSITION OF TAP

AZIMUTH ANGLE	F1-B1	F22	F3-B3	F4-B4	F5-B5	F6-B6
-5	19.8	13.8	7.7	5.5	6.60	5.65
-10	25.1	13.5	7.0	4.6	9.64	6.40
-15	33.8	13.1	7.2	7.6	5.43	5.05
-20	21.7	6.1	5.8	6.6	7.20	7.30
-25	8.7	6.1	5.9	5.4	6.92	8.05
-30	12.0	3.9	4.8	5.7	6.13	5.20
-35	8.0	4.0	4.5	6.5	6.13	4.53
-40	6.6	9.2	8.5	5.4	7.53	9.17
-50	9.2	3.3	6.1	4.4	7.86	8.20
-60	6.6	13.5	8.4	8.8	9.92	7.86
-70	10.0	7.6	7.7	7.3	9.03	6.92
-80	16.9	6.7	9.7	6.6	10.71	8.20
-90	12.6	10.2	10.4	10.2	12.21	6.44

TABLE 8 (cont'd)

DYNAMIC HEAD = 0.86 MM OF HG.

DATE OF EXPERIMENT = August 31, 1970

ANGLES MEASURED IN DEGREES = +90 TO ZERO TO -90

POSITION OF TAP

AZIMUTH ANGLE	F7-B7	F8-B8	F9-B9	F10-B10	F11-B11	F12-B12
90	1.6	1.8	1.7	1.7	2.19	2.52
75	1.3	1.6	2.4	3.2	4.20	5.19
60	4.8	5.6	6.4	8.7	10.10	11.30
50	8.7	7.8	6.3	10.3	11.20	11.77
45	9.3	11.5	12.0	11.8	12.29	15.13
40	10.6	15.4	13.7	13.9	14.71	16.93
35	14.9	17.6	19.1	15.4	18.28	17.99
30	25.0	23.2	21.2	20.7	21.16	25.37
25	34.7	34.0	34.1	27.0	23.76	28.22
20	36.4	43.0	38.9	35.7	29.47	32.79
15	36.6	40.7	38.1	38.2	38.84	36.48
10	23.3	25.5	30.7	33.3	33.04	35.02
5	18.9	34.7	18.2	23.7	35.46	45.77
0	10.9	21.8	16.8	18.7	15.45	20.03
-5	9.6	10.1	13.0	14.2	14.94	17.18
-10	8.1	11.8	12.3	13.5	15.08	16.56
-15	13.2	15.3	19.5	14.5	17.46	15.32
-20	6.6	5.8	7.6	12.6	12.75	12.87

TABLE 8 (cont'd)

POSITION OF TAP						
AZIMUTH ANGLE	F7-B7	F8-B8	F9-B9	F10-B10	F11-B11	F12-B12
-30	11.6	14.3	13.5	12.7	11.70	17.99
-40	8.0	8.1	11.8	14.5	13.07	12.61
-50	8.5	10.0	7.6	14.1	7.08	8.08
-60	1.3	.9	3.8	.5	.64	-4.39
-75	-1.0	-.3	1.4	-1.1	-1.19	-4.31
-90	-3.2	-1.9	-.1	-3.1	-3.75	-7.09

TABLE 8 (cont'd)

DYNAMIC HEAD = 0.86 MM OF HG.

DATE OF EXPERIMENT = August 31, 1970

ANGLES MEASURED IN DEGREES = +90 TO ZERO TO -90

POSITION OF TAP				
AZIMUTH ANGLE	F13-B13	F14-B14	F15-B15	F16-B16
90	3.20	6.12	9.78	21.25
85	4.34	8.36	11.38	29.15
80	5.53	9.28	13.71	22.89
75	5.71	10.33	12.79	30.39
70	6.21	10.24	12.57	20.70
65	9.46	12.25	16.18	25.18
60	9.82	15.17	14.44	26.87
55	11.38	15.72	20.01	27.19
50	13.02	15.72	19.92	26.32
45	14.94	21.84	25.64	29.02
40	13.30	21.57	21.39	24.81
35	19.24	21.11	22.48	24.36
30	21.57	23.81	24.08	32.54
25	31.80	35.37	29.25	25.36
20	33.59	37.06	32.99	32.67
15	31.03	40.49	36.28	47.93
10	47.52	36.33	33.72	53.97
5	48.39	47.20	37.47	45.88

TABLE 8 (cont'd)

POSITION OF TAP

AZIMUTH ANGLE	F13-B13	F14-B14	F15-B15	F16-B16
0	27.28	35.23	27.05	33.31
-5	16.22	17.59	14.26	9.46
-10	7.40	13.85	6.90	11.65
-20	6.76	9.32	11.38	17.87
-30	14.39	12.15	13.48	19.60
-40	18.28	19.28	22.07	18.00
-50	6.99	9.92	15.99	27.05
-60	10.88	12.57	13.66	16.36
-75	10.01	13.85	12.02	19.05
-90	6.08	9.87	12.79	15.72

TABLE 9. VARIATION OF C'_{prms} WITH α FOR DIFFERENT TAPS

α	C_4 C'_{prms}	α	C_5 C'_{prms}	α	C_6 C'_{prms}	α	F_1 C'_{prms}
+30	.012	+30	.050	+30	.044	-20	.187
+25	.044	+28	.061	+25	.117	-18	.213
+20	.072	+25	.085	+20	.233	-16	.271
+15	.092	+23	.108	+15	.303	-14	.321
+10	.121	+20	.114	+10	.379	-13	.335
+ 5	.142	+15	.118	+ 7	.417	-12	.321
+ 7	.145	+12	.120	+ 5	.432	-10	.309
0	.142	+10	.131	+ 3	.435	- 5	.265
- 5	.131	+ 5	.152	+ 1	.423	0	.228
-10	.112	0	.163	0	.408	+ 5	.178
-12	.110	- 3	.163	- 2	.388	+10	.125
-14	.119	- 5	.160	- 4	.365	+13	.105
-15	.135	- 7	.146	- 6	.250	+16	.096
-16	.149	-10	.131	- 8	.309	+20	.085
-16.5	.141	-12	.131	-10	.300	+25	.061
-17	.103	-14	.137	-15	.292	+30	.047
-18	.091	-15	.146	-16	.365	+35	.044
-20	.082	-16	.187	-17	.403	+40	.044
-25	.068	-17	.222	-18	.239		
-30	.063	-17.5	.155	-20	.175		
		-18	.137	-25	.111		
		-19	.120	-30	.079		
		-20	.111				
		-25	.088				
		-30	.076				

TABLE 9. VARIATION OF C'_{prms} WITH α FOR DIFFERENT TAPS - Cont'd.

F_2		F_3		F_4		F_5	
α	C'_{prms}	α	C'_{prms}	α	C'_{prms}	α	C'_{prms}
-20	.093	-20	.079	-20	.082	-20	.070
-15	.131	-15	.090	-15	.096	-15	.079
-10	.149	-10	.096	-10	.102	-10	.093
- 8	.152	- 5	.114	- 5	.117	- 5	.105
- 6	.149	- 2	.131	- 2	.123	0	.107
- 4	.146	0	.120	0	.120	-15	.05
- 2	.137	+ 2	.108	+ 5	.105	+10	.117
0	.128	+ 5	.093	+10	.111	+15	.145
+15	.102	+10	.082	+15	.131	+20	.175
+10	.079	+15	.085	+20	.158	+23	.189
+15	.076	+20	.096	+23	.166	+25	.182
+20	.079	+23	.090	+25	.158	+27	.168
+25	.070	+25	.079	+30	.137	+30	.159
+30	.058	+27	.070	+35	.134	+33	.152
+35	.061	+30	.073	+40	.117	+35	.147
+40	.067	+35	.090			+37	.135
		+40	.123			+40	.093

TABLE 9. VARIATION OF C'_{prms} WITH α FOR DIFFERENT TAPS - Cont'd.

F_6		F_7		F_8		F_9	
α	C'_{prms}	α	C'_{prms}	α	C'_{prms}	α	C'_{prms}
-20	.076	-20	.093	-20	.070	-20	.079
-15	.102	-15	.105	-15	.090	-15	.096
-10	.114	-10	.114	-10	.099	-10	.111
- 5	.120	- 5	.120	- 5	.111	- 5	.120
0	.123	0	.128	0	.120	0	.131
+ 5	.131	+ 5	.146	+ 5	.143	+ 5	.152
+10	.155	+10	.175	+10	.178	+10	.184
+15	.195	+15	.216	+15	.216	+15	.236
+17	.213	+20	.230	+20	.260	+20	.268
+20	.222	+23	.251	+22	.265	+22	.263
+23	.236	+25	.249	+23	.263	+25	.248
+25	.233	+28	.219	+25	.254	+30	.210
+30	.201	+30	.201	+30	.204	+35	.160
+33	.195	+35	.152	+35	.155	+40	.125
+35	.160	+40	.120	+40	.117		
+40	.128						

TABLE 9. VARIATION OF C'_{prms} WITH F_{10} , F_{11} , F_{12} , AND F_{13} FOR DIFFERENT TAPS - Cont'd

F_{10}		F_{11}		F_{12}		F_{13}	
α	C'_{prms}	α	C'_{prms}	α	C'_{prms}	α	C'_{prms}
-20	.096	-20	.082	- 5	.125	-10	.146
-15	.120	-15	.112	0	.137	- 5	.166
-10	.134	-10	.121	+ 5	.166	0	.190
- 5	.140	- 5	.131	+10	.230	+ 5	.222
0	.149	0	.142	+12	.257	+10	.292
+ 5	.172	+ 5	.166	+14	.265	+13	.309
+10	.207	+10	.208	+16	.263	+15	.309
+15	.280	+13	.259	+20	.245	+20	.286
+18	.292	+15	.278	+25	.216	+25	.251
+20	.289	+16	.280	+30	.184	+30	.222
+25	.257	+18	.275	+35	.149	+35	.193
+30	.213	+20	.264	+40	.123	+40	.172
+35	.172	+25	.233	+45	.105	+45	.160
+40	.149	+30	.203	+50	.088	+50	.152
		+35	.161	+55	.070		
		+40	.131				

TABLE 9. VARIATION OF C'_{prms} WITH α FOR DIFFERENT TAPS - Cont'd.

F_{14}		F_{15}		F_{16}	
α	C'_{prms}	α	C'_{prms}	α	C'_{prms}
-10	.137	-10	.146	-10	.178
- 5	.149	- 5	.178	- 5	.207
0	.190	0	.222	0	.245
+ 5	.228	+ 4	.277	+ 5	.300
+10	.286	+ 5	.286	+ 8	.306
+12	.303	+ 6	.292	+10	.306
+15	.295	+ 8	.289	+13	.300
+20	.280	+10	.280	+15	.292
+25	.260	+15	.257	+20	.280
+30	.230	+20	.239	+25	.265
+35	.204	+25	.219	+30	.251
+40	.190	+30	.201	+35	.248
+45	.178	+35	.190	+40	.248
+50	.198	+40	.184	+45	.251
		+45	.178	+50	.248
		+50	.172		

TABLE 10. MEAN PRESSURE COEFFICIENTS FOR POSITIONS -- T_3 , T_4 , T_5 , T_9 ,
 T_{10} , T_6 , T_7 , T_8 , T_{11} , T_{12} . MEASURED WITH RESPECT TO FREE
 STREAM STATIC PRESSURE.

Dynamic Head = 0.86 mm of HG.

Date of Experiment =

Angles Measured in Degrees = +90 and -90.

Position of Tap

Azimuth					
angle	T_3	T_4	T_5	T_9	T_{10}
+90	1.273	-1.276	-1.410	-1.236	-1.312
-90	-0.999	-1.133	-0.900	-1.487	-1.312

Dynamic Head = 0.83 mm of HG.

Date of Experiment =

Angles Measured in Degrees = +90 and -90

Azimuth					
angle	T_6	T_7	T_8	T_{11}	T_{12}
+90	-1.661	-1.803	-1.729	-1.791	-1.903
-90	-1.962	-2.081	-1.903	-1.788	-1.815